

«Web sémantique et métadonnées»

Norme internationale ISO/IEC 19788 – Métadonnées pour les ressources d'apprentissage (MLR)

Gilles Gauthier

Professeur associé, Département d'informatique,
UQAM

Convener ISO/IEC JTC1 SC36/WG4 (2005-2011)

Vice-président au développement, GTN-Québec

GTN-Québec

Groupe québécois de travail sur les normes et standards
pour l'apprentissage, l'éducation et la formation

2 novembre 2012





Plan de la présentation

1. Introduction
2. Organisation internationale de normalisation (ISO)
3. Présentation de la norme internationale ISO/IEC 19788 *Metadata for learning resources*
4. MLR et Web sémantique
5. Web des données
6. Bibliographie



1. INTRODUCTION

Un peu d'histoire !

Linked Data

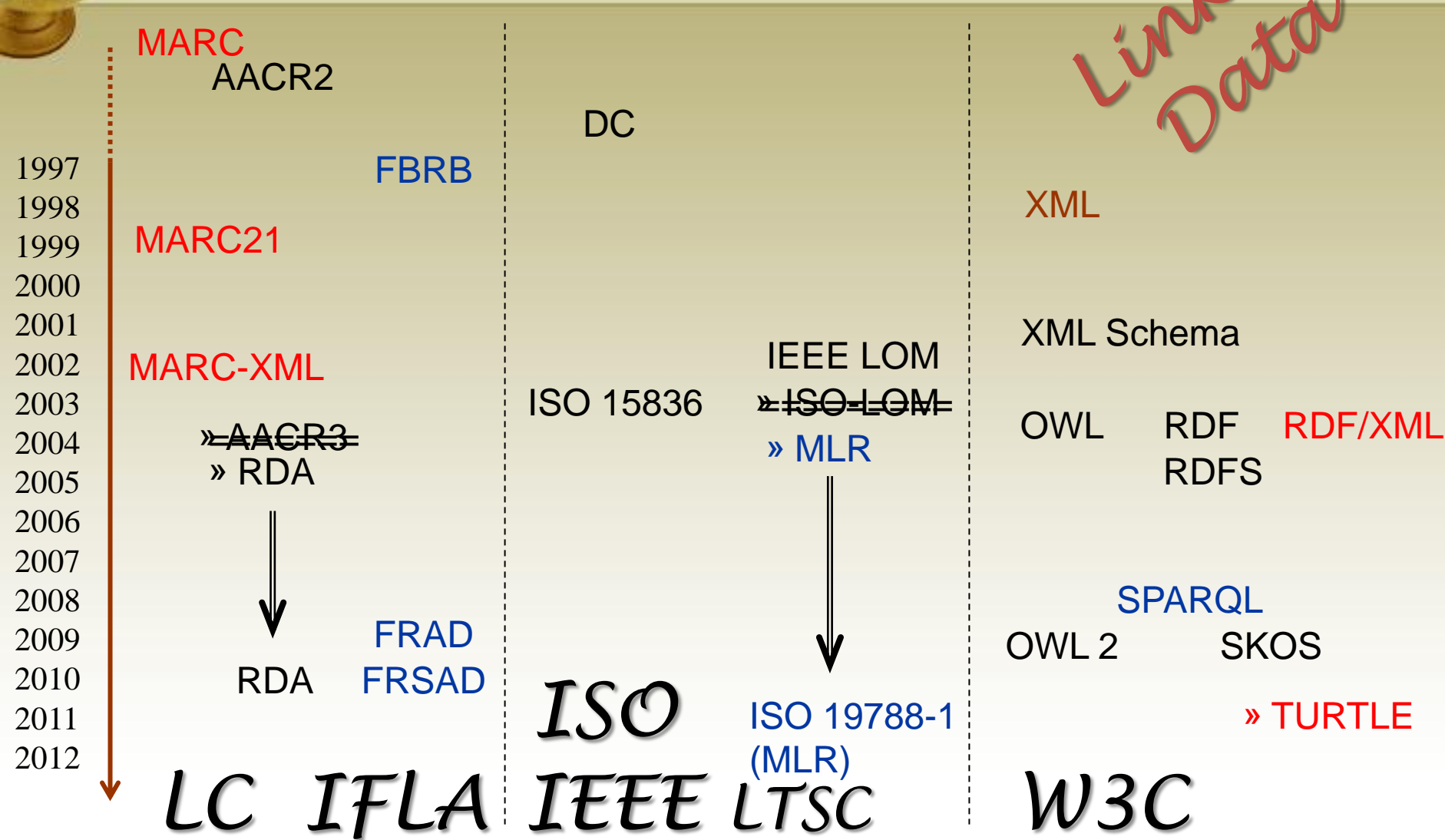

Où vivent les métadonnées ?

Where do metadata live?

In centralized or distributed
Learning Object Repositories

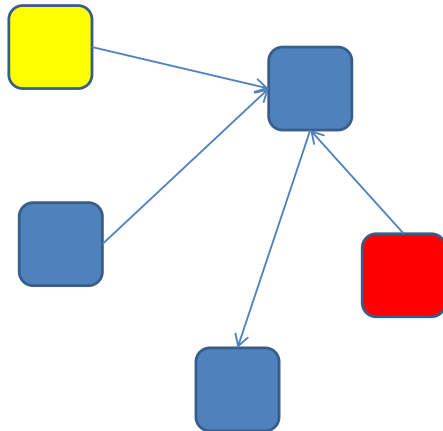

Free in the Web

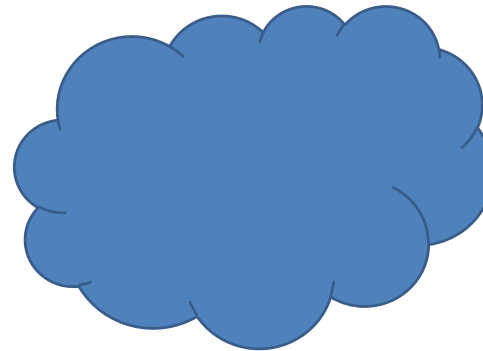

Who contributes metadata
for a learning resource?



2. ORGANISATION INTERNATIONALE DE NORMALISATION (ISO)



ISO

CEI

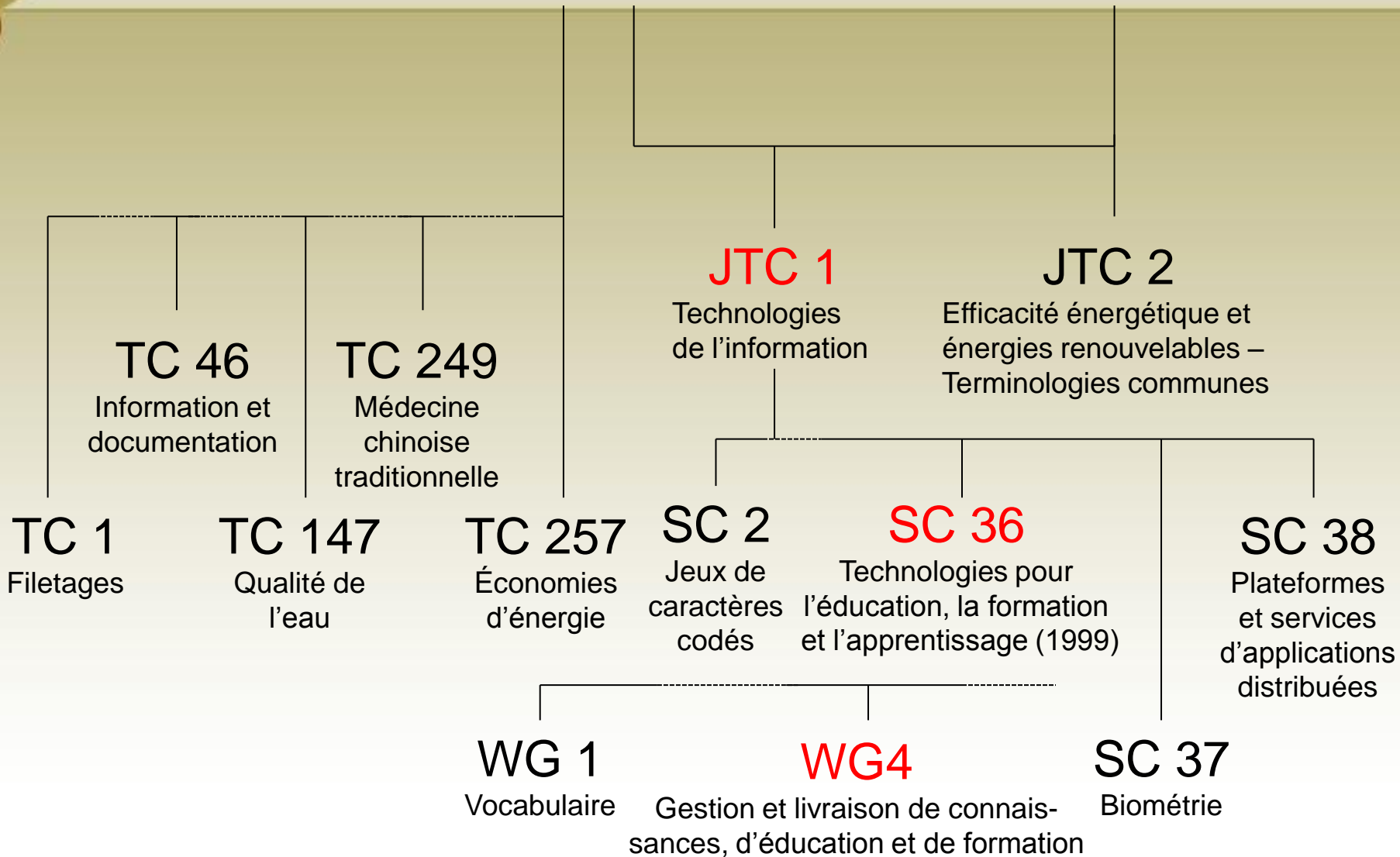



3. PRÉSENTATION DE LA NORME INTERNATIONALE ISO/IEC 19788 *METADATA FOR LEARNING RESOURCES*

Parties de l'ISO/IEC 19788

Extrait du « scope » de l'ISO/IEC 19788

The primary purpose of ISO/IEC 19788 is to specify metadata elements and their attributes for the description of learning resources. [...]

ISO/IEC 19788 provides data elements for the description of learning resources and resources directly related to learning resources.

Partie 1: *Framework* (2011)

Partie 2: *Dublin Core elements* (2011)

Partie 3: *Basic application profile* (2011)

Partie 4: *Technical elements* (en développement)

Partie 5: *Educational elements* (2012)

Partie 6: *Availability, distribution, and intellectual property elements* (en développement)

Partie 7: *Bindings* (en développement)

Partie 8: *Data elements for MLR records* (en développement)

Partie 9: *Data elements for Persons* (en développement)

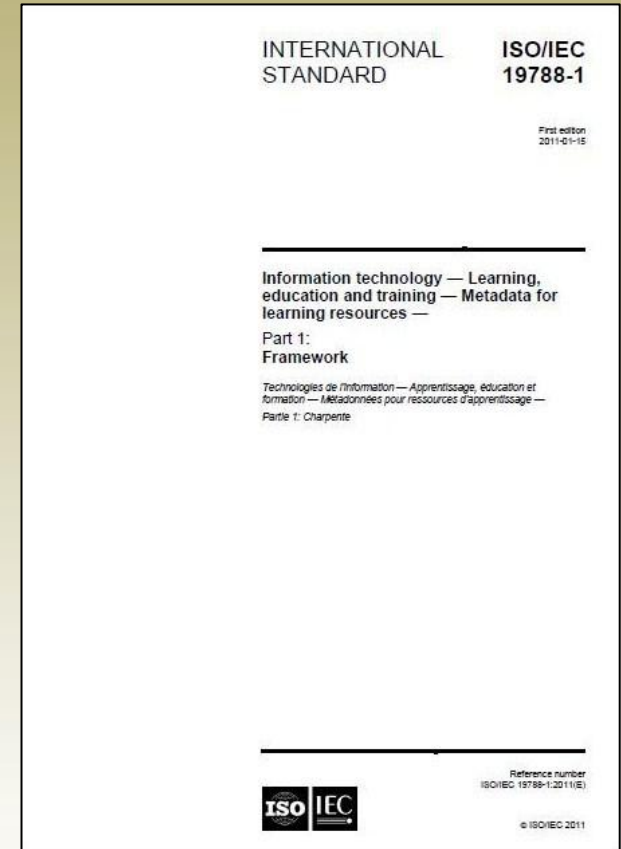



Principes guidant le développement de la norme MLR

- Une norme multipartie (approche modulaire)
- Développement dirigé par les besoins des utilisateurs
- Considération de la diversité culturelle et linguistique
- Support pour différents niveaux de granularité
- Réutilisation des normes internationales et autres normes, standards et spécifications
- Possibilité d'extension par les utilisateurs (profils d'application)



MLR-1: Framework / Charpente

- Présente les principes appliqués au développement de l'ISO/IEC 19788
- Indique comment décrire des *Data Element Specifications*
- Définit rigoureusement ce qu'est un élément de donnée
- Concept de *MLR record*
- Spécifie la structure des parties (tant pour les parties spécifiant des éléments de données que celles décrivant des profils d'application)
- Utilisation de ISO/IEC 10646 / Unicode
- Définit rigoureusement ce qu'est un profil d'application



- Le MLR-1 est indépendant de la technologie
- Toutes les entités décrites dans le MLR-1
 - spécification d'éléments de données,
 - éléments de données,
 - enregistrement MLR,
 - classes de ressources,
 - vocabulaires,
 - termes d'un vocabulaire

Juliet:

"What's in a name? That which we call a rose
By any other name would smell as sweet."

Romeo and Juliet (Act II, ii, 43-44)

possèdent obligatoirement un identifiant global,
persistant et linguistiquement neutre

- Rétro-compatibilité avec IEEE 1484.12.1-2002 (IEEE LOM) et ISO 15836:2009 (DC)

[LOM2MLR, DC2MLR, MARC2MLR \(GitHub\)](#)

Carte conceptuelle pour le MLR-1

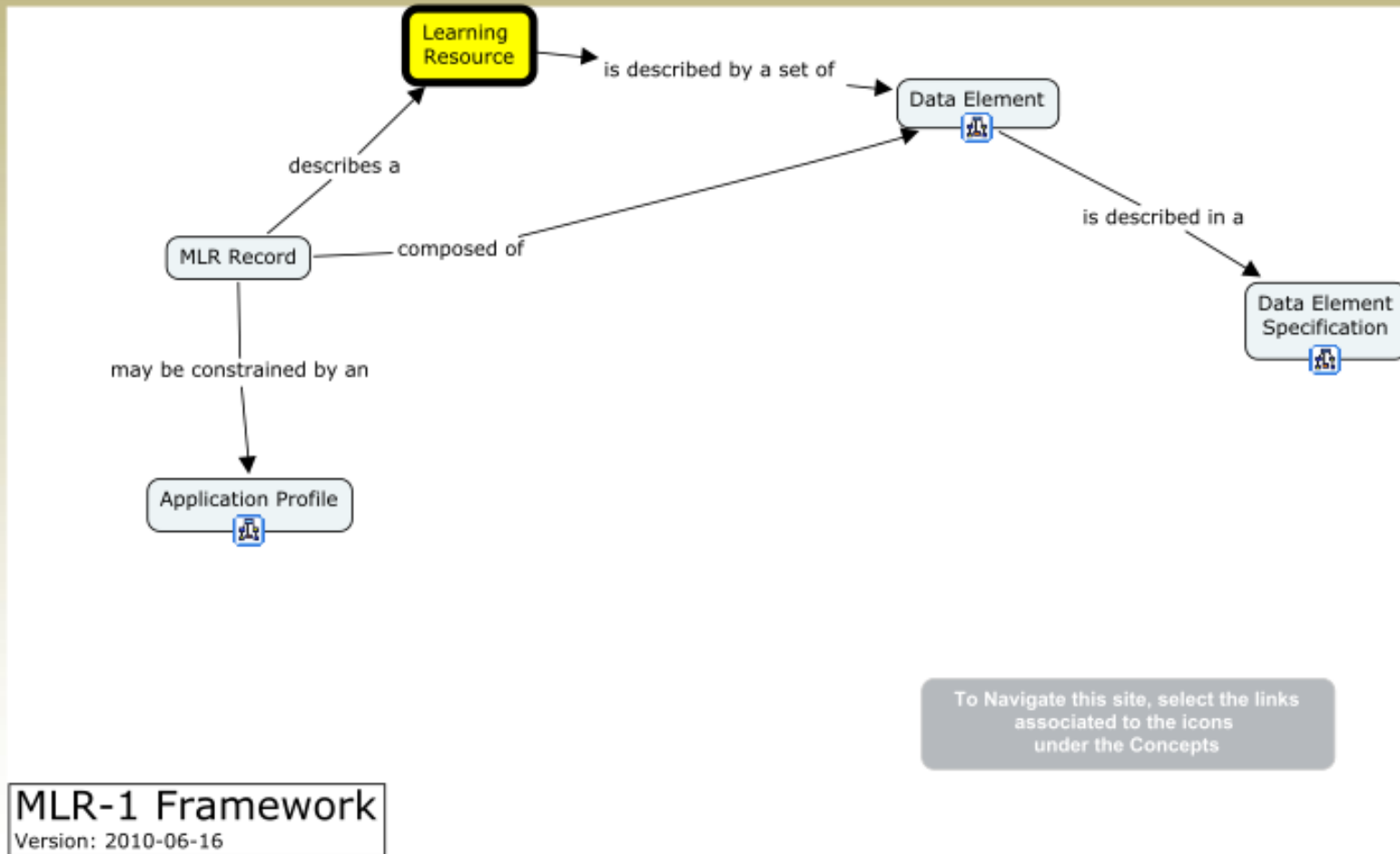

Éléments de base

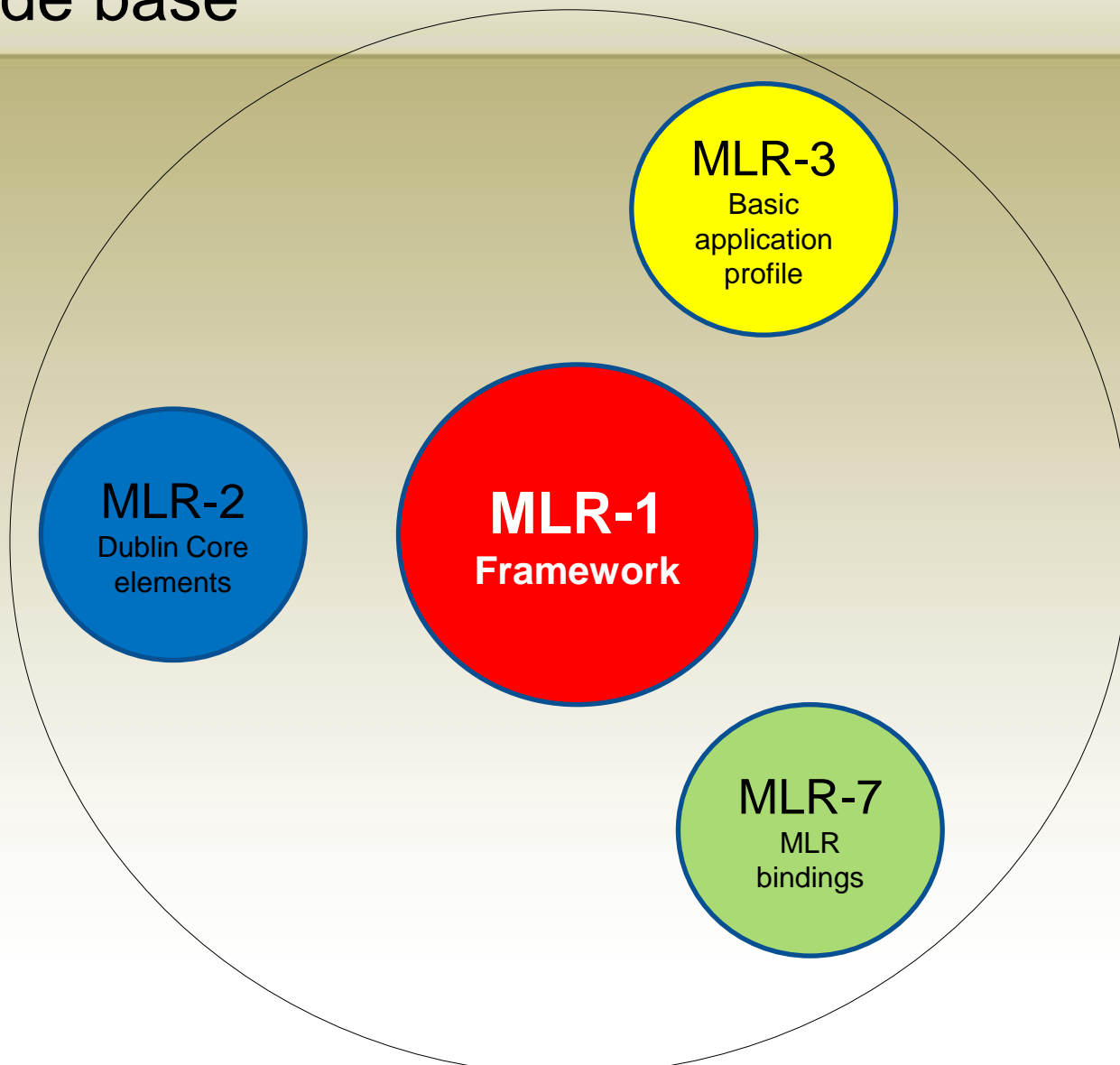

Éléments de données « classiques »

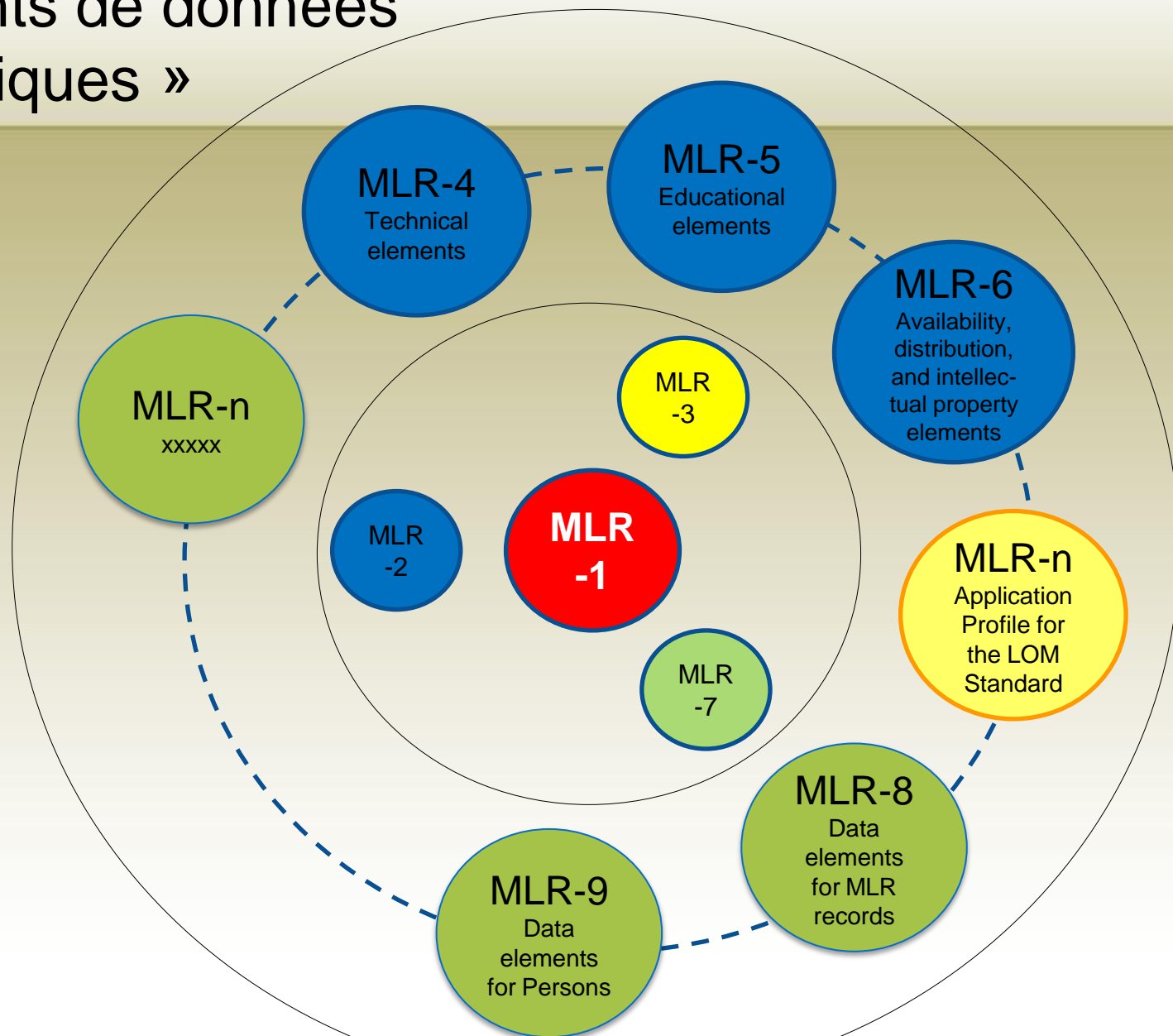

À la frontière (explorations)

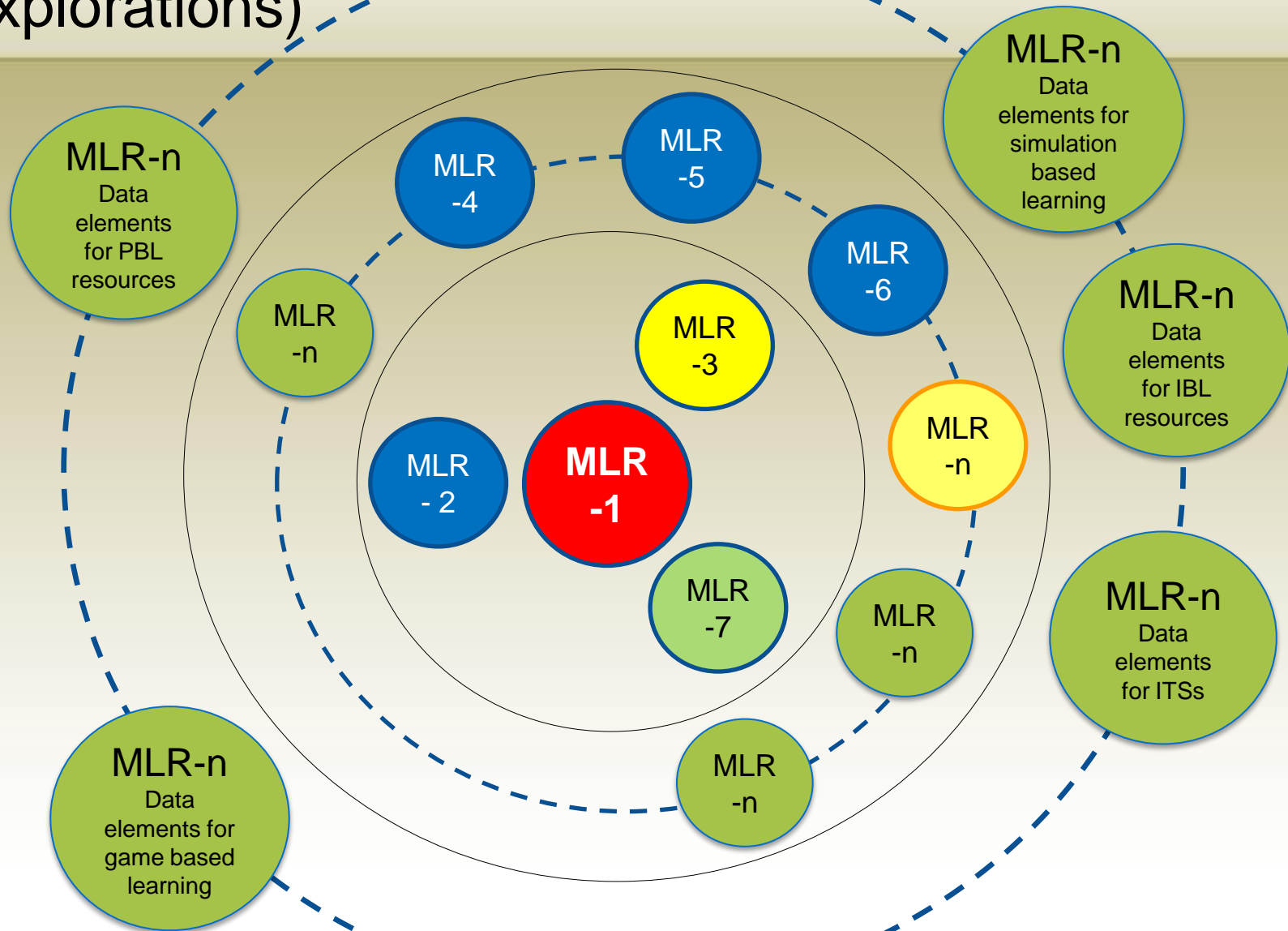

Carte conceptuelle pour « éléments de données »

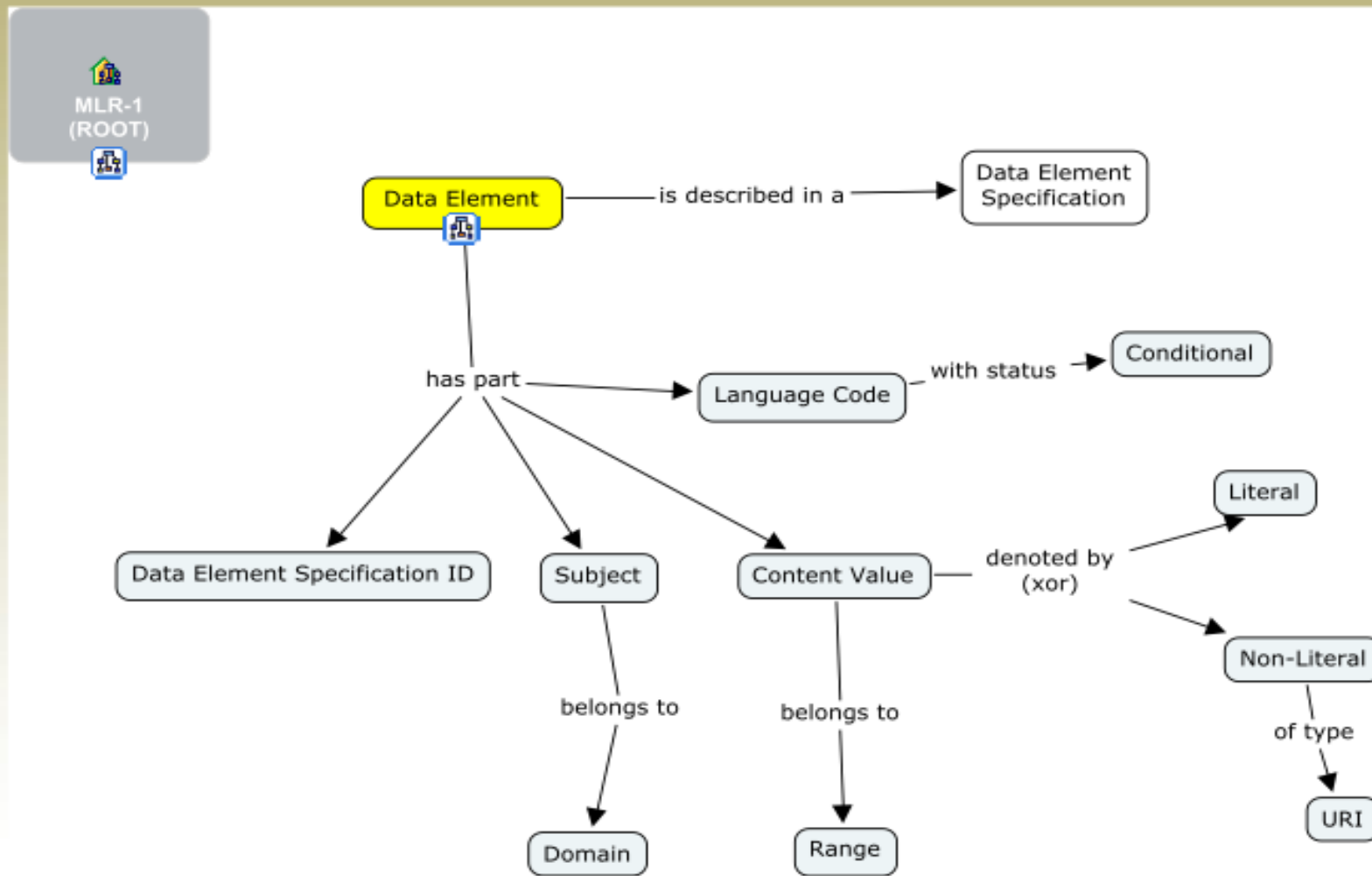

Instance d'une SED

URI http (RFC 5141)

| Data element specification | |
|--------------------------------|--|
| Identifier | ISO_IEC_19788-3:2010::DES0300 |
| Data element attributes | |
| Property name | format (eng) |
| Definition | file format of the learning resource |
| Linguistic indicator | non linguistic |
| Domain | <i>Learning Resource</i> (ISO_IEC_19788-1:2010::RC0002) |
| Range | <i>literal</i> |
| Content value rules | RS_DES0100 |
| Refines | ISO_IEC_19788-2:2010::DES0900 (format) |
| Example(s) | video/mpeg text/html |
| Note(s) | To avoid ambiguity, a specific data element, introduced in ISO_IEC_19788-4: Technical elements, must be used for duration. |

| ID : RS_DES0100 | |
|-----------------|--|
| Rule_ID | Rule statement / Example(s) & Note(s) |
| 01 | Is a MLR STRING(ISO_IEC_19788-1:2010::PRS0001) |
| 02 | Is a MIME Media Type |

Instance d'une SED (2)

| Data element specification | |
|--------------------------------|---|
| Identifier | ISO_IEC_19788-5:2010::DES0300 |
| Data element attributes | |
| Property name | contributor (eng) |
| Definition | agent responsible for making contributions for the description of the learning resource |
| Linguistic indicator | non linguistic |
| Domain | <i>Learning Resource</i> (ISO_IEC_19788-1:2010::RC0002) |
| Range | <i>Contributor</i> (ISO_IEC_19788-5:2010::RC0001) |
| Content value rules | N/A |
| Refines | - |
| Example(s) | - |
| Note(s) | - |

Classes de ressources et propriétés

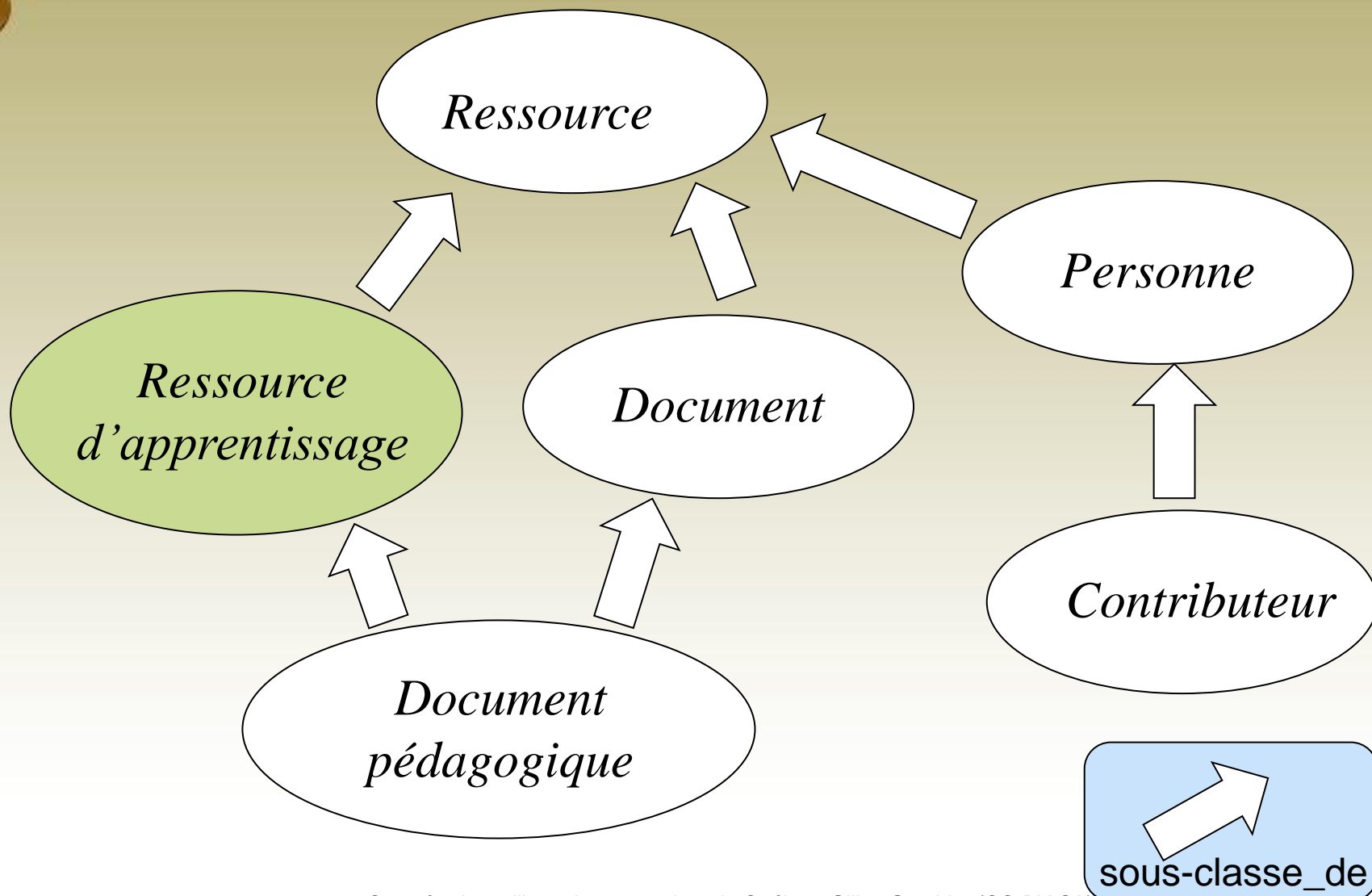

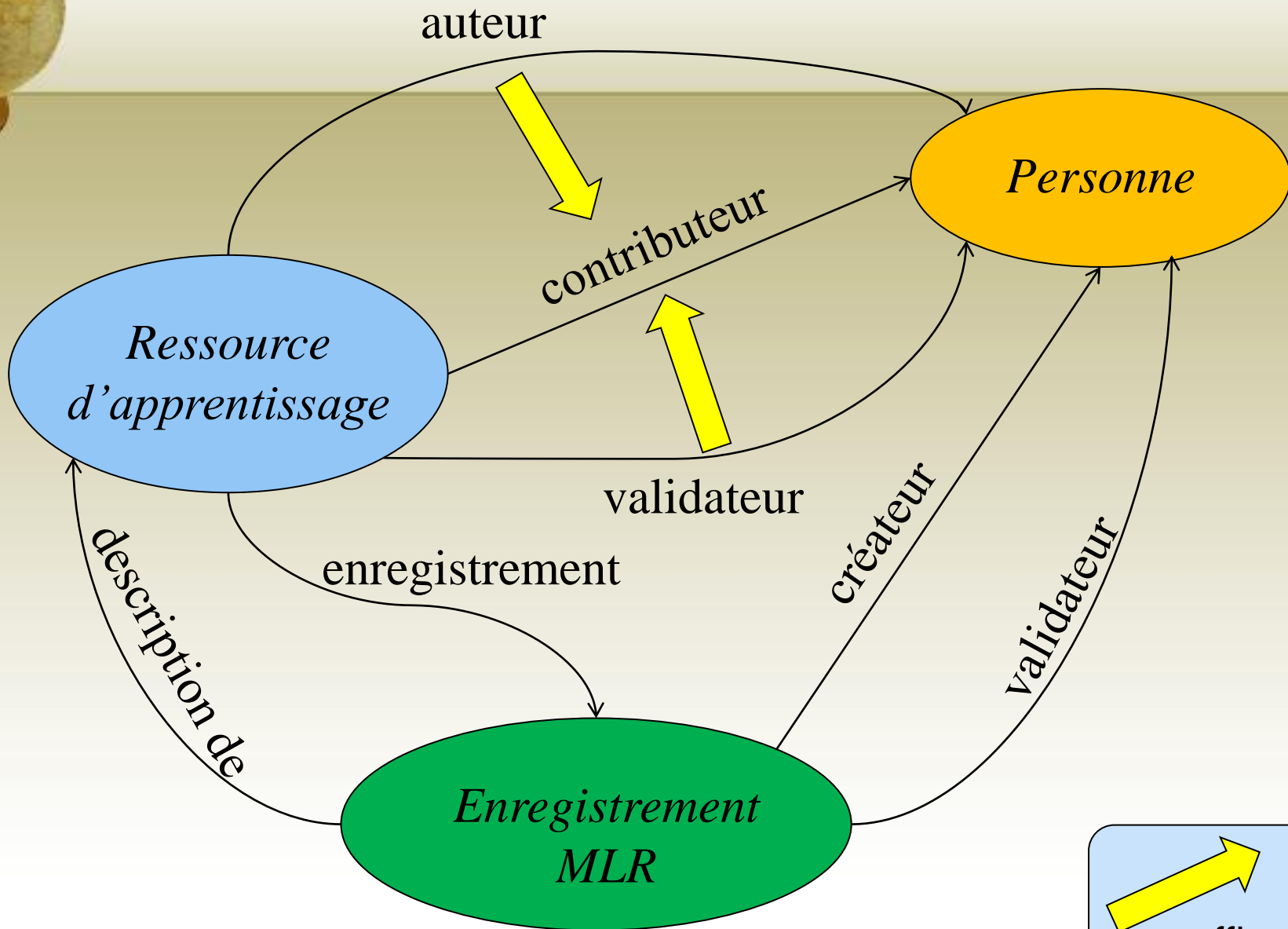

Élément de donnée (littéral)

| | |
|-------------------------------|------------------------------------|
| Data element specification ID | ISO_IEC_19788-2:2011::DES0100 |
| Subject | urn:isbn:0-262-18162-2 |
| Content Value | Turtle, Termites, and Traffic Jams |
| Language Code | eng |

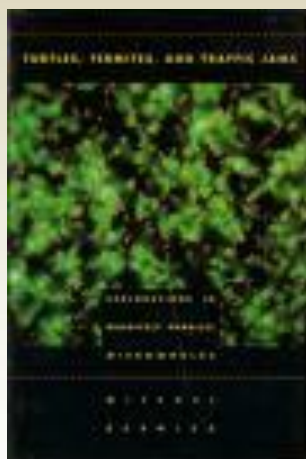

| Term ID | ISO English | ISO French | ISO Russian |
|-------------------------------|-------------|------------|---------------------|
| ISO_IEC_19788-2:2010::DES0100 | title | titre | заголовок |
| ISO_IEC_19788-2:2010::DES0200 | creator | créateur | автор |
| ISO_IEC_19788-2:2010::DES0300 | subject | sujet | тема |
| ... | | | |
| ISO_IEC_19788-2:2010::DES1500 | rights | droits | правовая информация |

Élément de donnée (ressource)

| | |
|-------------------------------|---|
| Data element specification ID | ISO_IEC_19788-5:2010::DES0300 |
| Subject | urn:uuid:9f945ae0-fc99-11df-87b0-0002a5d5c51b |
| Content Value | urn:uuid:c9474ea0-fd0d-11df-af05-0002a5d5c51b |

ISO_IEC_19788-5:2010::DES0300

Property name: contributeur (fra)

Domain: ISO_IEC_19788-1:2010::RC0002 (*Ressource d'apprentissage* (fra))

Range: ISO_IEC_19788-3:2010::RC0001 (*Contributeur* (fra))

“[...] everything of importance deserves a URI. Go ahead and give yourself a URI. You deserve it!

[Tim Berners-Lee](#)



MLR-1
(ROOT)

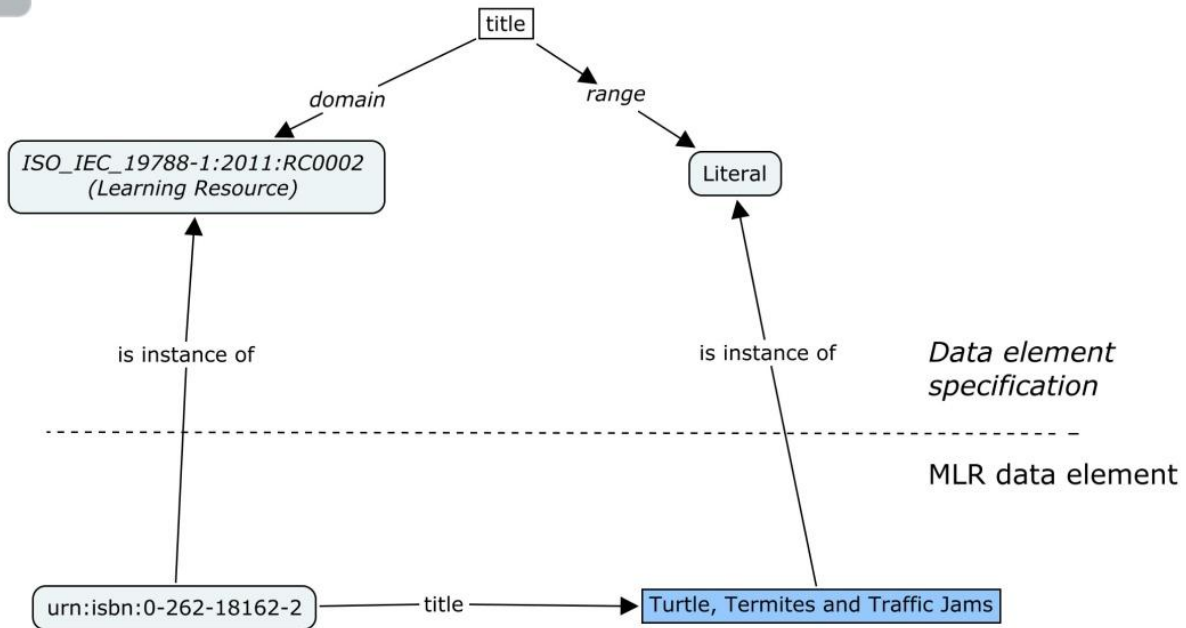



Profils d'application MLR

Construits en conformité avec l'article 12 de l'ISO/CEI 19788-1: « *12 Specification of application profiles* »

Chaque profil d'application comporte les items suivants:

- spécifications des éléments de données (SED)
- définitions de classes de ressources
- définitions d'ensembles de règles
- spécifications de groupes d'éléments de données (SGED)
- spécification du profil d'application
- descriptions de vocabulaires



Collection de spécifications d'éléments de données (SED):

- provenant de parties de l'ISO/CEI 19788
- provenant d'autres sources (e.g. IEEE LOM, RDA)
- introduits spécifiquement pour les besoins d'une communauté spécifique (éléments locaux)

On peut:

- mettre des contraintes sur la présence, la répétition ou l'ordre d'apparition des instances d'éléments de données dans un *enregistrement MLR*
- on peut restreindre ou étendre les vocabulaires utilisés pour les valeurs des éléments de données (*dégradation progressive de l'information*)



Vocabulaires

ISO_IEC_19788-3:2010::VA.2 DCMI Type Vocabulary

| ID | Anglais | Français | Russe |
|-----------|----------------------|-----------------------|----------------------|
| T001 | collection | collection | подборка |
| T002 | dataset | ensemble de données | набор данных |
| T003 | interactive resource | ressource interactive | интерактивный ресурс |
| ... | | | |
| T010 | text | texte | текст |

Vocabulaires (2)

ISO_IEC_19788-3:2010::VA.2 DCMI Type Vocabulary

| ID | China (SAC) ¹ | | Canada (SCC) | |
|------|--------------------------|--------------------|-------------------------|----------------------|
| | Chinese (zho/Hans) | Chinese (zho/Hant) | French (fra) | English (eng) |
| T001 | 集合 | 集合 | collection | collection |
| T002 | 数据集 | 數據集 | ensemble de données | dataset |
| T003 | 互动资源 | 互動資源 | ressources interactives | interactive resource |
| ... | | | | |
| T010 | 文本 | 文本 | texte | text |

¹ Traductions à titre d'exemple seulement (traduit en utilisant les outils linguistiques de Google)

ISO 15924:2004 *Information and documentation – Codes for the representation of names of scripts / Information et documentation – Codes pour la représentation des noms des écritures*
 Hans: Han (Simplified variant) / Hant: Han (Traditional variant)



4. MLR ET WEB SÉMANTIQUE



De MLR à RDF: en un coup d'oeil

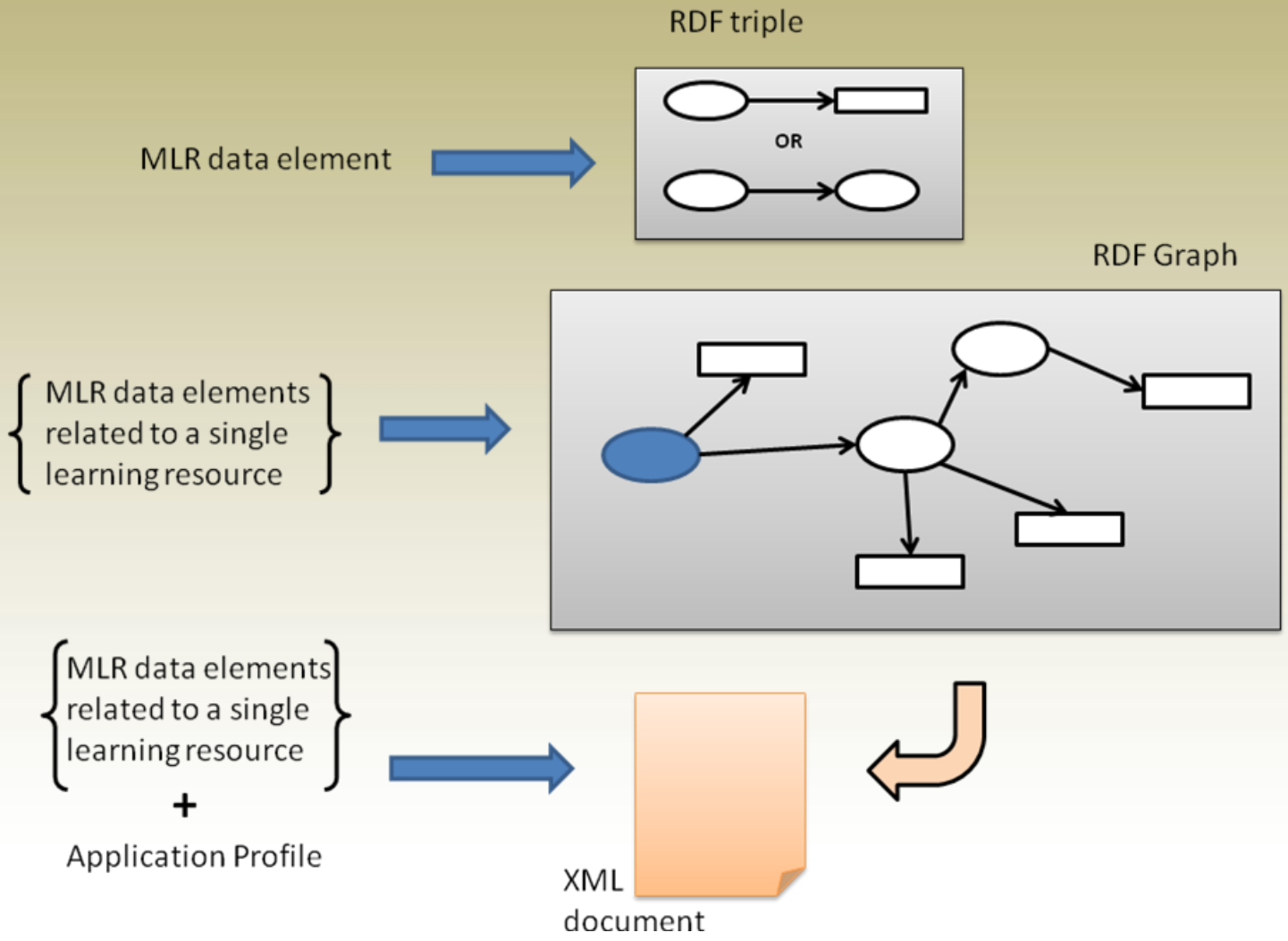

Une ressource d'apprentissage



Title: Turtles, Termites, and Traffic Jams
Author: Mitchel Resnick
Publisher: The MIT Press
Publication date: 1994
Copyright: ©1994 Massachusetts
Institute of Technology
ISBN: 0-262-18162-2

Graphe RDF (selon MLR-7: Bindings)

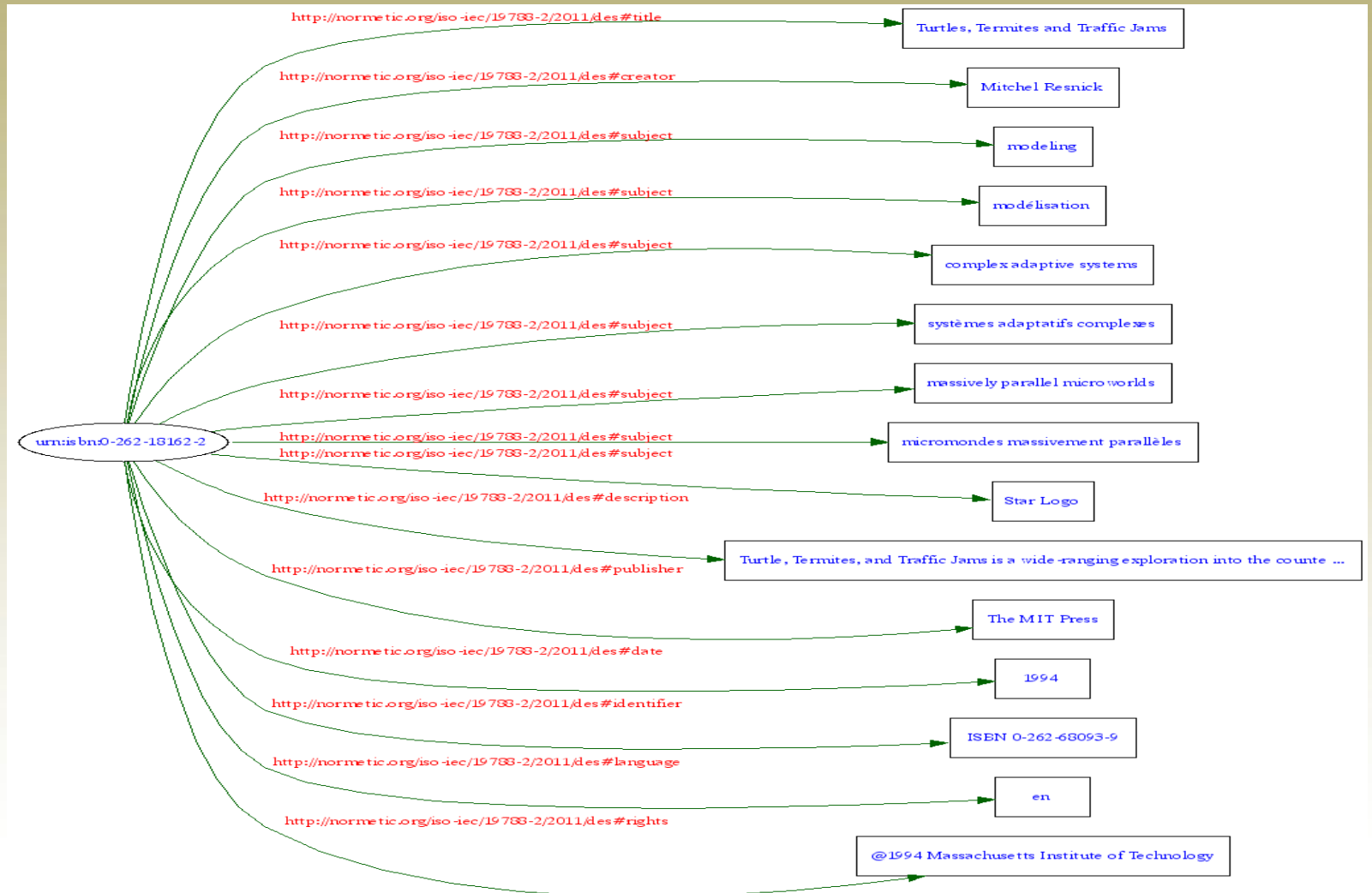



Sérialisation (*Turtle*)

```
@prefix rdf: <http://www.w3.org/1999/02/22-rdf-syntax-ns#> .
@prefix mlr2: <http://normetic.org/iso-iec/19788-2/2011/des#> .
<urn:isbn:0-262-18162-2> mlr2:creator "Mitchel Resnick"@en ;
    mlr2:date "1994" ;
    mlr2:description "Turtle, Termites, and Traffic Jams is a wide-
        ranging exploration into the counterintuitive world of
        decentralized systems and self-organizing phenomena"@en ;
    mlr2:identifrier "ISBN 0-262-68093-9" ;
    mlr2:language "en" ;
    mlr2:publisher "The MIT Press"@en ;
    mlr2:rights "@1994 Massachusetts Institute of Technology"@en ;
    mlr2:subject "complex adaptive systems"@en ,
        "massively parallel microworlds"@en ,
        "micromondes massivement parallèles"@fr ,
        "modeling"@en ,
        "modélisation"@fr ,
        "Star Logo"@en ,
        "systèmes adaptatifs complexes"@fr ;
    mlr2:title "Turtles, Termites and Traffic Jams"@en .
```

Ontologie pour l'ISO/IEC 19788 (OWL)

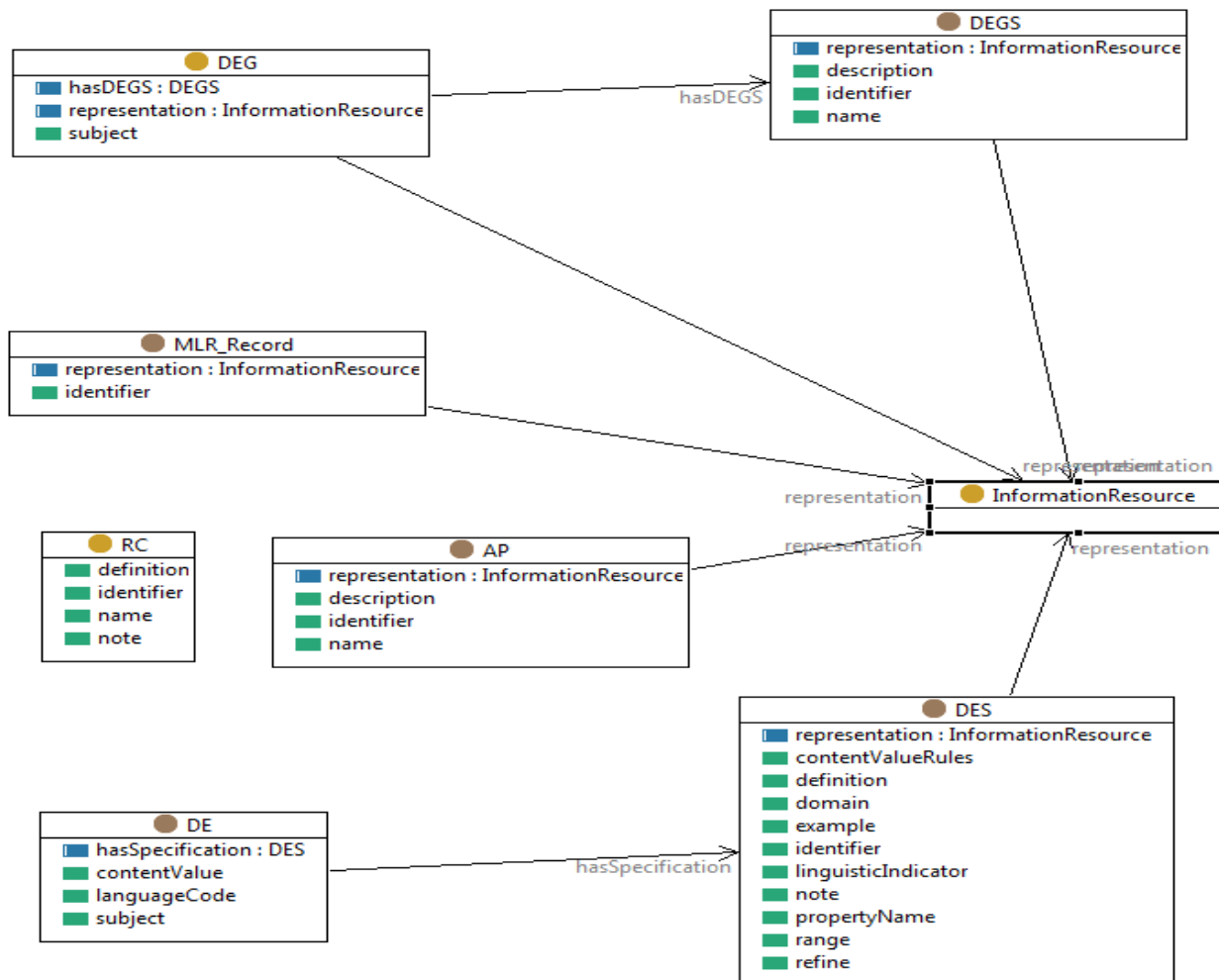



Vocabulaires (SKOS)

Extrait du vocabulaire (de valeurs)

ISO_IEC_19788-5:2012::VA.2 (*Audience role*)

```
@prefix rdf:      <http://www.w3.org/1999/02/22-rdf-syntax-ns#> .
@prefix rdfs:     <http://www.w3.org/2000/01/rdf-schema#> .
@prefix skos:    <http://www.w3.org/2004/02/skos/core#> .
@base <http://normetic.org/iso-iec/19788-5/2012/va.2> .
```

```
<http://standards.iso.org/iso-iec/19788/-5/ed-1/clause/va.2>
  rdf:type skos:ConceptScheme ;
  rdfs:label "ISO_IEC_19788-5:2012::VA.2" ;
  rdfs:label "Audience role"@en .
```

```
<#t010>
  rdf:type skos:Concept ;
  skos:inScheme <http://standards.iso.org/iso-iec/19788/-5/ed-1/clause/va.2> ;
  skos:prefLabel "learner"@en , "apprenant"@fr ;
  skos:definition "one who learns or receives instruction"@en ,
    "apprenant ou personne recevant de l'enseignement"@fr ;
  skos:note "The English definition is taken from IEEE 1484.12.1-2002,
    IEEE Standard for Learning Object Metadata" .
```

```
<#t020>
```

Extension d'un vocabulaire

Vocabulary **Extended opportunity types**

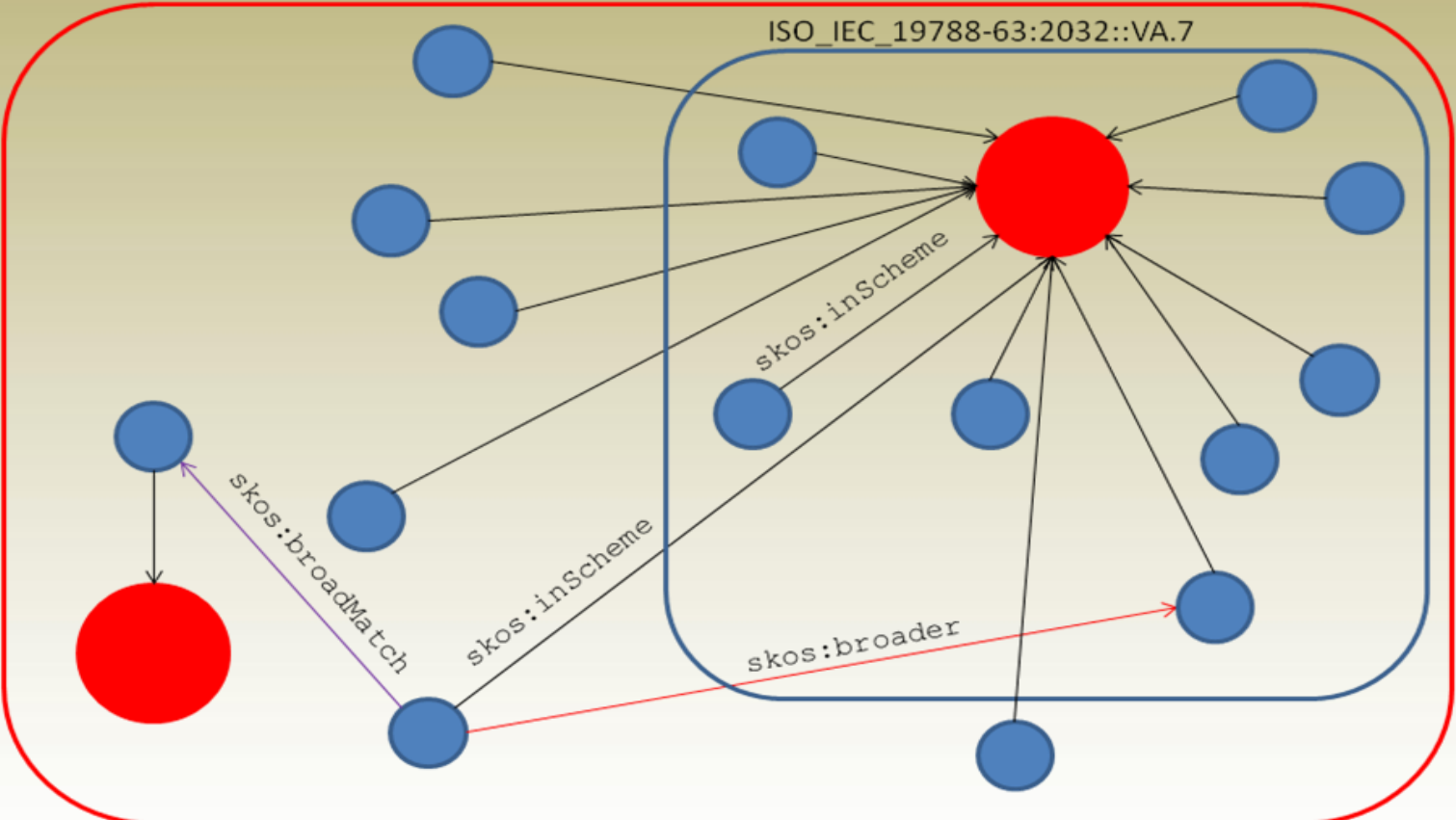

-  skos:ConceptScheme
-  skos:Concept
-  black arrow: skos:inScheme
-  red arrow: skos:broader
-  purple arrow: skos:broadMatch

Description d'une ressource « vivant sur le Web »

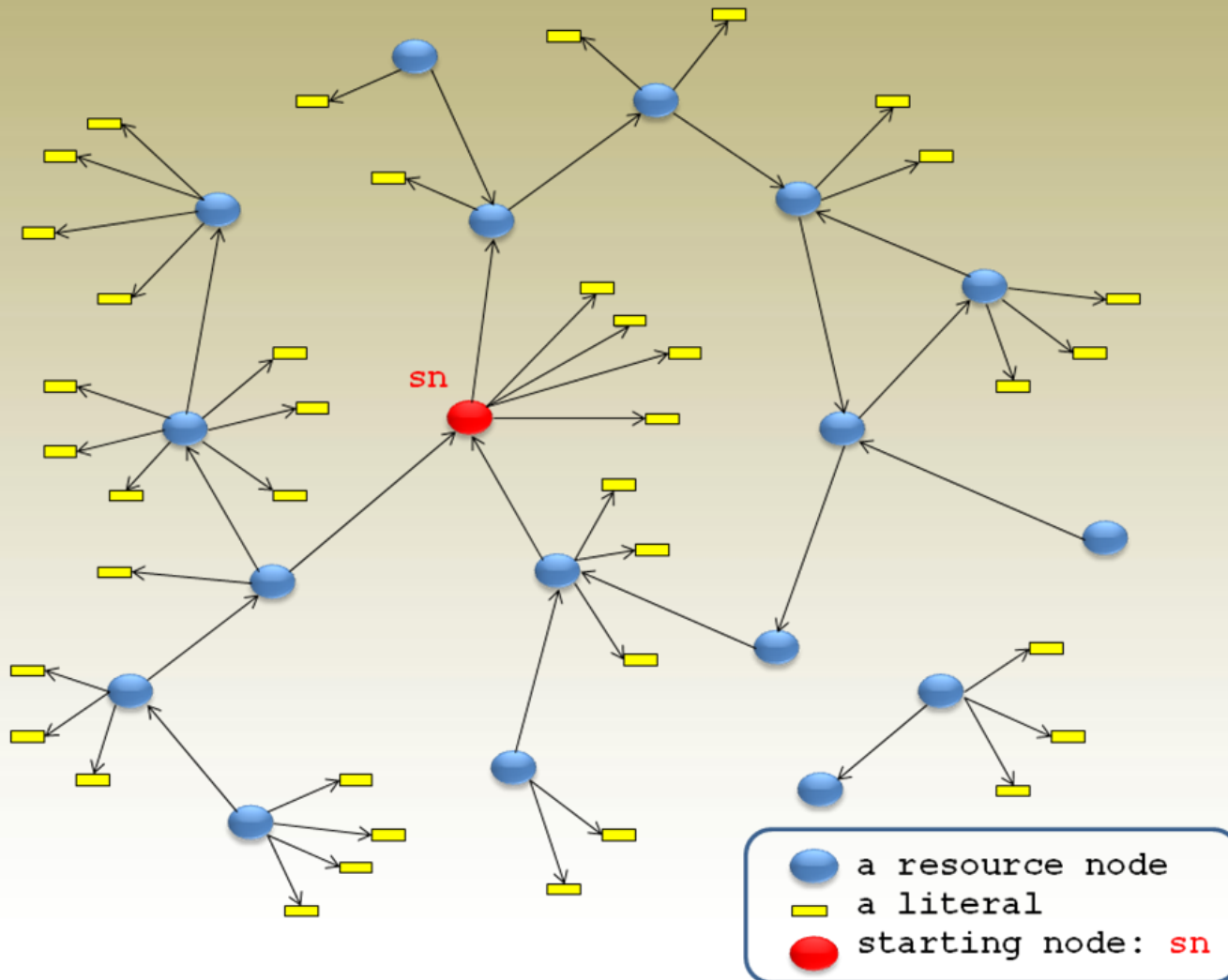

Bounded description d'une ressource

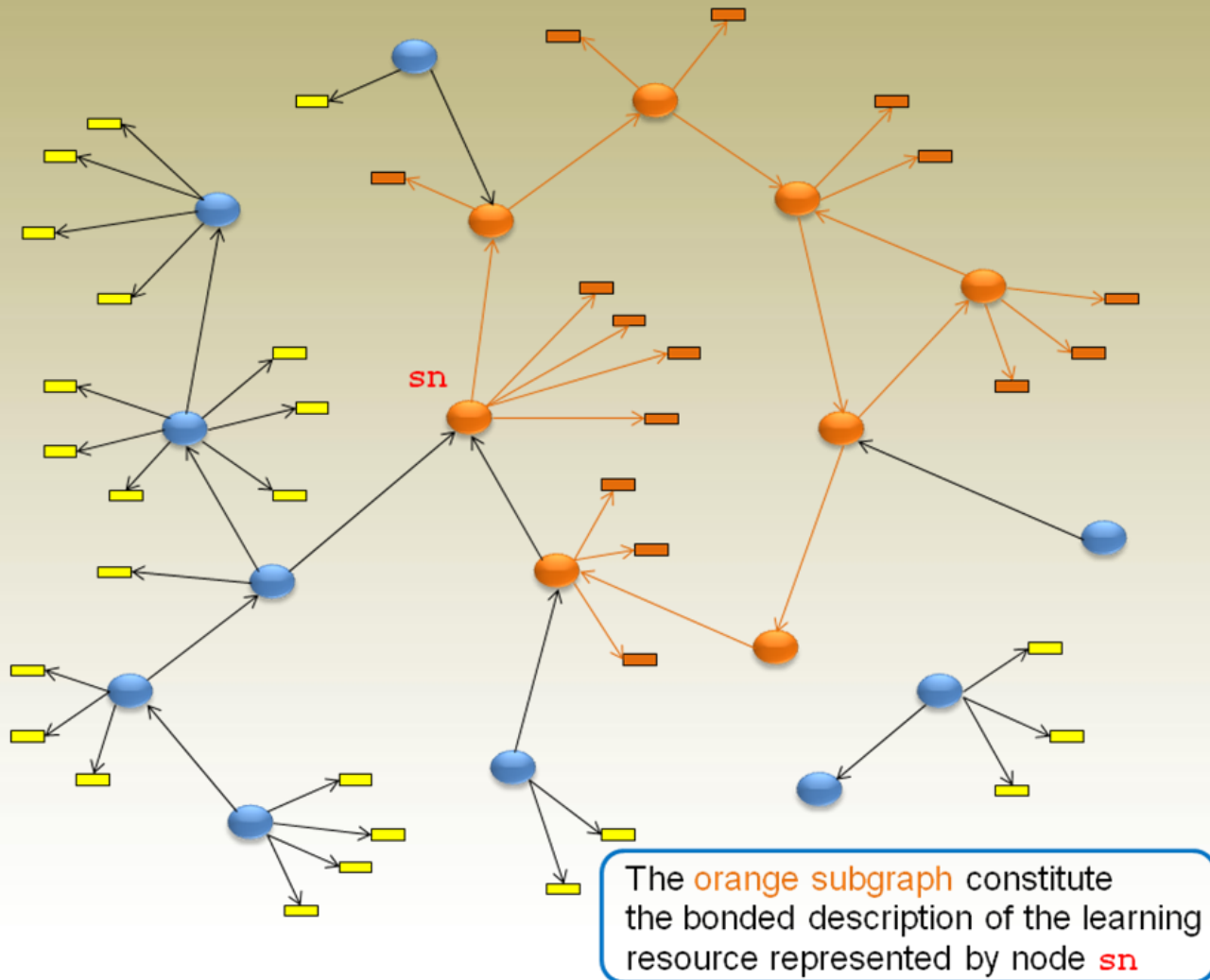



5. WEB DES DONNÉES (*LINKED DATA*)

Wikipedia

The screenshot shows a web browser window displaying the French Wikipedia article for René Lévesque. The browser's address bar shows the URL http://fr.wikipedia.org/wiki/Ren%C3%A9_L%C3%A9vesque. The page features the Wikipedia logo, a navigation menu, and the article content. The article title is "René Lévesque" and it includes a summary, a table of contents, and a detailed biography. A photograph of a bronze statue of René Lévesque is visible on the right side of the page.

René Lévesque
(Redirigé depuis René Levesque)

Pour les articles homonymes, voir René Lévesque (homonymie).

René Lévesque (né le 24 août 1922 à Campbellton au Nouveau-Brunswick, mort le 1^{er} novembre 1987 à Verdun) est un journaliste, animateur de radio et de télévision, député, ministre et chef politique québécois. Indépendantiste québécois, il fonde le Parti québécois en 1968 et exerce la fonction de premier ministre du Québec de 1976 à 1985.

Sommaire [masquer]

- 1 Biographie
 - 1.1 Famille
 - 1.2 Éducation
 - 1.3 Carrière journalistique
 - 1.3.1 Débuts à la radio
 - 1.3.2 Correspondant de guerre
 - 1.3.3 Personnalité publique
 - 1.4 Carrière politique
 - 1.4.1 Ministre des Ressources hydrauliques et des Travaux publics
 - 1.4.2 Ministre des Richesses naturelles
 - 1.4.3 Ministre de la Famille et du Bien-être social
 - 1.4.4 Élection de 1966
 - 1.4.5 Fondateur du MSA et président du Parti Québécois
 - 1.4.6 Premier mandat (1976-1980)
 - 1.4.6.1 Référendum sur la Souveraineté-Association
 - 1.4.6.2 Négociations constitutionnelles
 - 1.4.7 Deuxième mandat (1981-1985)
 - 1.5 Retour au journalisme
 - 1.6 Vie privée
- 2 Héritage politique
 - 2.1 Hydro-Québec
 - 2.2 Parti québécois
 - 2.3 Système électoral
 - 2.4 Politique linguistique
 - 2.5 Projet de pays
- 3 Chronologie
- 4 Écrits

René Lévesque



Fonctions

23^e premier ministre du Québec

25 novembre 1976 – 3 octobre 1985
(8 ans, 10 mois et 8 jours)

Prédécesseur Robert Bourassa
Successeur Pierre Marc Johnson

Biographie

Date de naissance 24 août 1922
Lieu de naissance à Campbellton (Nouveau-Brunswick)
Date de décès 1^{er} novembre 1987 (à 65 ans)

http://dbpedia.org/resource/René_Lévesque

File Edit View Favorites Tools Help

Plan... lom2... NASA... Chro... Easy... Prop... Adva... Sema... Link... Desi... Info... Forv... Open... ITS... Sema... Tool...

About: René Lévesque

An Entity of Type : [politician](#), from Named Graph : <http://dbpedia.org>, within Data Space : [dbpedia.org](#)



René Lévesque (August 24, 1922 – November 1, 1987) was a reporter, a minister of the government of Quebec, (1960–1966), the founder of the Parti Québécois political party and the 23rd Premier of Quebec (November 25, 1976 – October 3, 1985). He was the first Quebec political leader since Confederation to attempt, through a referendum, to negotiate political separation for Quebec.

| Property | Value |
|--------------------------------------|--|
| dbpedia-owl:abstract | <ul style="list-style-type: none">■ René Lévesque fou un periodista i polític quebequès, Primer Ministre del Quebec de 1976 a 1985. Membre del Partit Liberal del Quebec i diputat al Parlament del Quebec des de 1960, va fundar el 1968 el Partit Quebequès, de caire independentista. Com a President del Quebec, va impulsar el 1980 un referèndum a favor de transformar Quebec a un "Estat lliure associat" amb el Canadà, que va ser rebutjat. El 1984 va moderar les seves posicions independentistes i l'octubre de 1985 va renunciar a la presidència del Partit Quebequès, sent reemplaçat per Pierre Marc Johnson. Va morir dos anys més tard producte d'un atac cardíac.■ René Lévesque, GOQ war der 27. Premierminister der primär französischsprachigen kanadischen Provinz Québec und Gründer des Parti Québécois, einer sich für die Sezession Québecs von Kanada einsetzenden Partei. Zuvor war er Reporter und Minister im Kabinett Lesage. Er war der erste québecische Staatsführer, der durch ein Referendum die Unabhängigkeit Québecs zu erreichen versuchte.■ René Lévesque (August 24, 1922 – November 1, 1987) was a reporter, a minister of the government of Quebec, (1960–1966), the founder of the Parti Québécois political party and the 23rd Premier of Quebec (November 25, 1976 – October 3, 1985). He was the first Quebec political leader since Confederation to attempt, through a referendum, to negotiate political separation for Quebec.■ René Lévesque fue un periodista y político canadiense, ligado al nacionalismo quebequès. Fue fundador del Partido Quebequès, formación de corte independentista, y ejerció como Primer Ministro de Quebec desde 1976 hasta 1985. Durante su mandato, impulsó en 1980 un referendun de autodeterminación, convirtiéndose en el primer político desde tiempos de la Confederación Canadiense que propuso la separación de Quebec del resto de Canadá. Cuando el electorado quebequès rechazó la secesión, Lévesque negoció con el Gobierno canadiense la aceptación de una nueva Constitución |

http://dbpedia.org/resource/René_Lévesque (2)

провинції).

- René Левек — видатний квебекський політик і журналіст, прем'єр-міністр Квебеку з 1976 до 1985 року, лідер та один з засновників Квебекської партії. Левек займав позиції державного суверенітету Квебеку: за роки його правління була прийнята Хартія французької мови та проведено перший референдум щодо державного суверенітету Квебеку (за суверенітет проголосувало 40% громадян провінції).

| | |
|----------------------------------|---|
| dbpedia-owl:activeYearsEndDate | ■ 1985-10-03 (xsd:date) |
| dbpedia-owl:activeYearsStartDate | ■ 1976-11-25 (xsd:date) |
| dbpedia-owl:birthDate | ■ 1922-08-24 (xsd:date) |
| dbpedia-owl:birthPlace | ■ dbpedia:Campbellton,_New_Brunswick ■ dbpedia:New_Brunswick ■ dbpedia:Canada |
| dbpedia-owl:deathDate | ■ 1987-11-01 (xsd:date) ■ 1987-11-24 (xsd:date) |
| dbpedia-owl:deathPlace | ■ dbpedia:Nuns_Island ■ dbpedia:Quebec ■ dbpedia:Canada |
| dbpedia-owl:individualisedPnd | ■ 119078198 |
| dbpedia-owl:orderInOffice | ■ Premier of Quebec ■ 23rd |
| dbpedia-owl:party | ■ dbpedia:Parti_Québécois |
| dbpedia-owl:profession | ■ dbpedia:Journalist |
| dbpedia-owl:religion | ■ dbpedia:Catholic_Church |
| dbpedia-owl:successor | ■ dbpedia:Pierre-Marc_Johnson |
| dbpedia-owl:thumbnail | ■ http://upload.wikimedia.org/wikipedia/commons/thumb/f/f3/René_Lévesque_WW2.jpg/200px-René_Lévesque_WW2.jpg |
| dbpedia-owl:wikiPageExternalLink | ■ http://archives.radio-canada.ca/IDD-0-17-1123/politique_economie/parti_quebecois_levesque/ ■ http://archives.cbc.ca/IDD-1-73-1092/politics_economy/Patriation/ ■ http://www.radio-canada.ca/nouvelles/dossiers/constitution/ |

http://dbpedia.org/isparql/ (SPARQL endpoint)

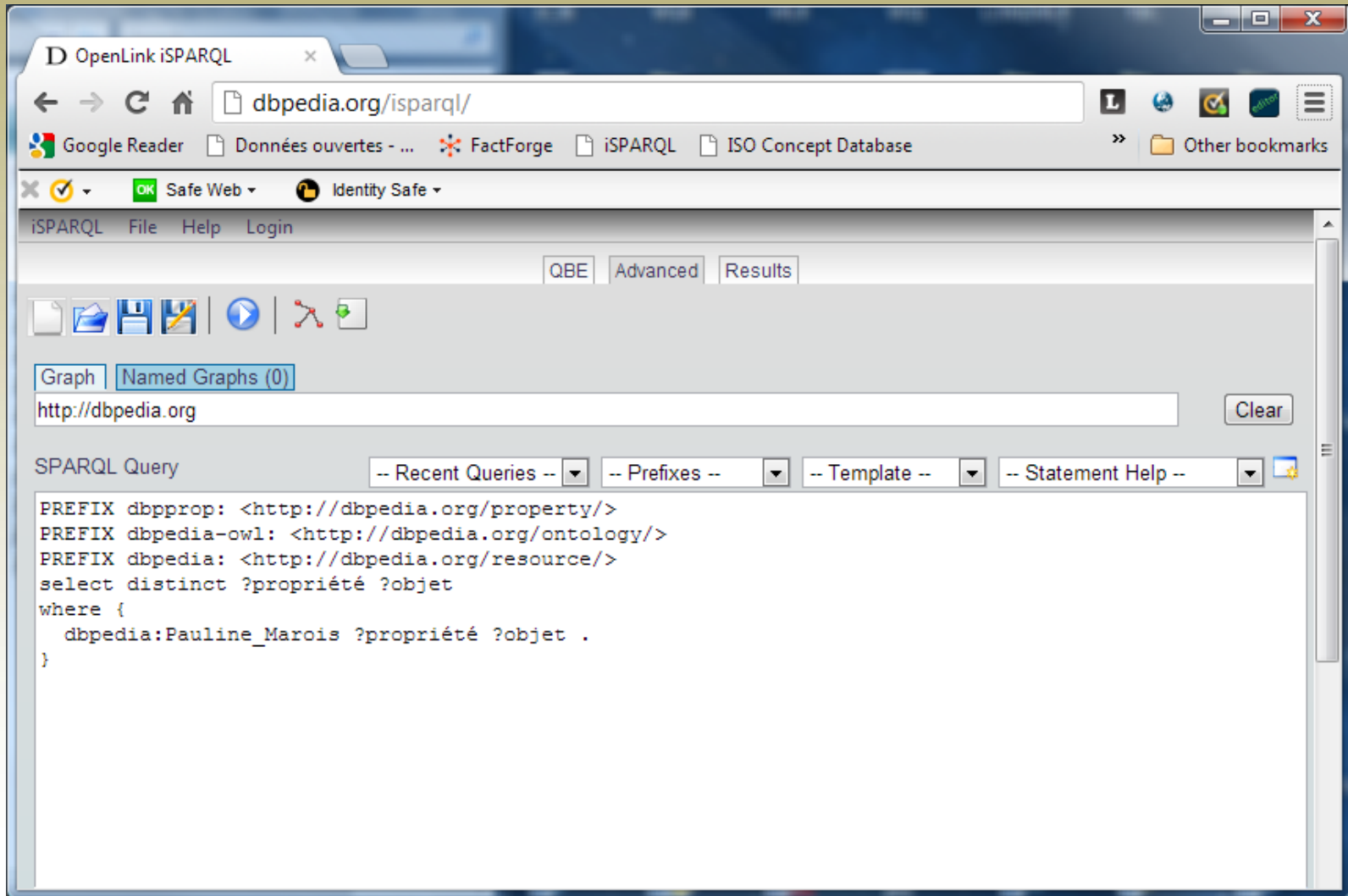

The screenshot shows the OpenLink iSPARQL web interface. The browser address bar displays `dbpedia.org/isparql/`. The interface includes a menu bar with "iSPARQL", "File", "Help", and "Login". Below the menu are tabs for "QBE", "Advanced", and "Results". A toolbar contains icons for file operations and navigation. A "Graph" section shows "Named Graphs (0)" and a URL input field containing `http://dbpedia.org` with a "Clear" button. The "SPARQL Query" section features dropdown menus for "Recent Queries", "Prefixes", "Template", and "Statement Help". The query text is as follows:

```
PREFIX dbpprop: <http://dbpedia.org/property/>
PREFIX dbpedia-owl: <http://dbpedia.org/ontology/>
PREFIX dbpedia: <http://dbpedia.org/resource/>
select distinct ?propriété ?objet
where {
  dbpedia:Pauline_Marois ?propriété ?objet .
}
```

http://dbpedia.org/isparql/ (SPARQL endpoint) (2)

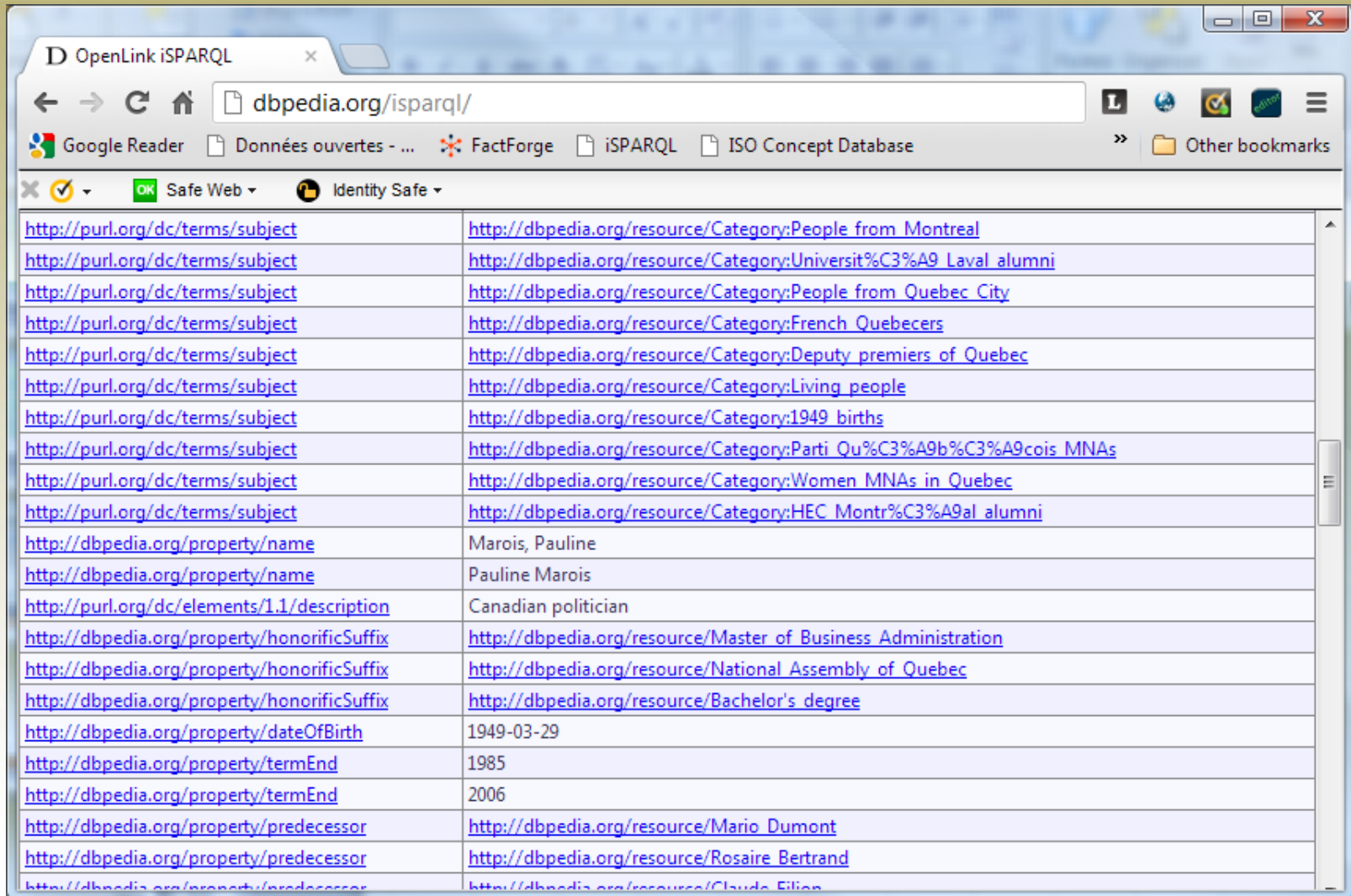

The screenshot shows a web browser window with the address bar containing 'dbpedia.org/isparql/'. The browser's address bar also shows 'OpenLink iSPARQL' and 'dbpedia.org/isparql/'. The browser's toolbar includes navigation buttons (back, forward, refresh, home) and a search bar. Below the toolbar, there are several bookmarks: 'Google Reader', 'Données ouvertes - ...', 'FactForge', 'iSPARQL', and 'ISO Concept Database'. The browser's status bar shows 'Safe Web' and 'Identity Safe'. The main content area displays a table of results from a SPARQL query. The table has two columns: the first column contains URIs, and the second column contains the corresponding values. The results are as follows:

| | |
|---|---|
| http://purl.org/dc/terms/subject | http://dbpedia.org/resource/Category:People from Montreal |
| http://purl.org/dc/terms/subject | http://dbpedia.org/resource/Category:Universit%C3%A9 Laval alumni |
| http://purl.org/dc/terms/subject | http://dbpedia.org/resource/Category:People from Quebec City |
| http://purl.org/dc/terms/subject | http://dbpedia.org/resource/Category:French Quebecers |
| http://purl.org/dc/terms/subject | http://dbpedia.org/resource/Category:Deputy premiers of Quebec |
| http://purl.org/dc/terms/subject | http://dbpedia.org/resource/Category:Living people |
| http://purl.org/dc/terms/subject | http://dbpedia.org/resource/Category:1949 births |
| http://purl.org/dc/terms/subject | http://dbpedia.org/resource/Category:Parti Qu%C3%A9bécois MNAs |
| http://purl.org/dc/terms/subject | http://dbpedia.org/resource/Category:Women MNAs in Quebec |
| http://purl.org/dc/terms/subject | http://dbpedia.org/resource/Category:HEC Montr%C3%A9al alumni |
| http://dbpedia.org/property/name | Marois, Pauline |
| http://dbpedia.org/property/name | Pauline Marois |
| http://purl.org/dc/elements/1.1/description | Canadian politician |
| http://dbpedia.org/property/honorificSuffix | http://dbpedia.org/resource/Master of Business Administration |
| http://dbpedia.org/property/honorificSuffix | http://dbpedia.org/resource/National Assembly of Quebec |
| http://dbpedia.org/property/honorificSuffix | http://dbpedia.org/resource/Bachelor's degree |
| http://dbpedia.org/property/dateOfBirth | 1949-03-29 |
| http://dbpedia.org/property/termEnd | 1985 |
| http://dbpedia.org/property/termEnd | 2006 |
| http://dbpedia.org/property/predecessor | http://dbpedia.org/resource/Mario Dumont |
| http://dbpedia.org/property/predecessor | http://dbpedia.org/resource/Rosaire Bertrand |
| http://dbpedia.org/property/predecessor | http://dbpedia.org/resource/Claude Eliott |

The linking Open Data cloud diagram

richard.cyganiak.de/2007/10/lo/od/

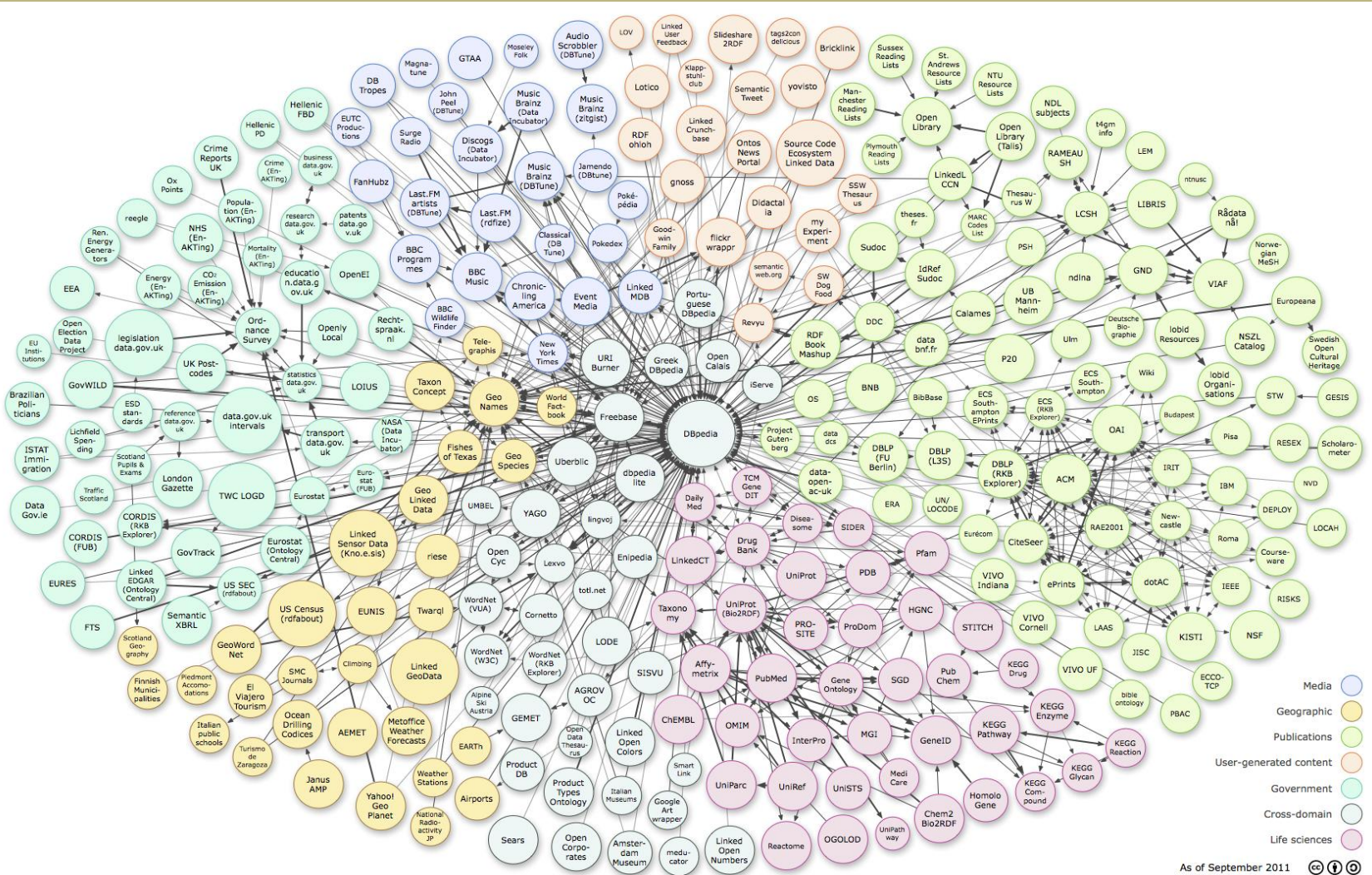

Web de données de la BnF (data.bnf.fr)

accueil (data.bnf.fr) x

data.bnf.fr

Google Reader Données ouvertes - ... FactForge iSPARQL ISO Concept Database ISO Electronic Appli... ODP - Open Directo... Other bookmarks

Safe Web Identity Safe

(BnF) Bibliothèque nationale de France

rechercher dans data.bnf.fr | À propos | Contact

data.bnf.fr

Des fiches de référence sur les auteurs, les œuvres et les thèmes

Bienvenue sur data.bnf.fr

La Bibliothèque nationale de France vous guide dans ses ressources en regroupant sur une même page toutes les informations issues de ses différents catalogues, ainsi que de sa bibliothèque numérique Gallica.

Vous (ré)utilisez les données de data.bnf.fr ? [Dites-le nous](#)

Enquête de l'Observatoire des publics de la BnF : [Votre avis nous intéresse](#)

LISTE DES AUTEURS >>>

LISTE DES ŒUVRES >>>

LISTE DES THÈMES >>>

Auteurs les plus consultés

- Alexandre Dumas (1802-1870)
- Claude Gallien (0131?-0201?)
- Victor Hugo (1802-1885)
- Jean de La Fontaine (1621-1695)
- Tacite (0055?-0120?)

Œuvres les plus consultées

- Fables
- Cantates
- Faits et dits du géant Gargantua
- La divine comédie
- La reine Margot

Regard sur

Érasme (1469-1536)

RDF
SKOS

Web de données de la BnF (data.bnf.fr) (2)

Vladimir Nabokov (1899-1977)



| | |
|-----------------|--|
| Pays : | États-Unis |
| Langue : | anglais, russe |
| Sexe : | masculin |
| Naissance : | 23-04-1899, Saint-Petersbourg (Russie) |
| Mort : | 02-07-1977, Montreux (Suisse) |
| Biographie : | A traduit aussi du russe en anglais |
| | Homme de lettres Chercheur en entomologie |
| Domaines : | Littératures |
| Autres formes : | Vladimir Sirine (1899-1977) Vladimir Sirin (1899-1977) Vivian Darkbloom (1899-1977) Vladimir Vladimirovitch Nabokov (1899-1977) Vladimir Nabokoff (1899-1977) |
| Sources : | BN Cat. gén. 1960-1969 : Nabokov, Vladimir Vladimirovitch, pseud. Vl. Sirin BN Service russe : Foster |
| | LC Authorities : Nabokov, Vladimir Vladimirovich (1899-1977) DLB, n° 2 American novelists since World War II, 1978 : http://authorities.loc.gov (2006-01-24) |

data.bnf.fr

> Voir les 161 documents au sujet de cet auteur

Outils

- Imprimer la page
- Exporter en PDF
- Signaler un problème sur la page

Ressources BnF

Recherche dans :

- Gallica
- Catalogue général
- BnF archives et manuscrits
- CNLJ - La Joie par les livres

http://factforge.net

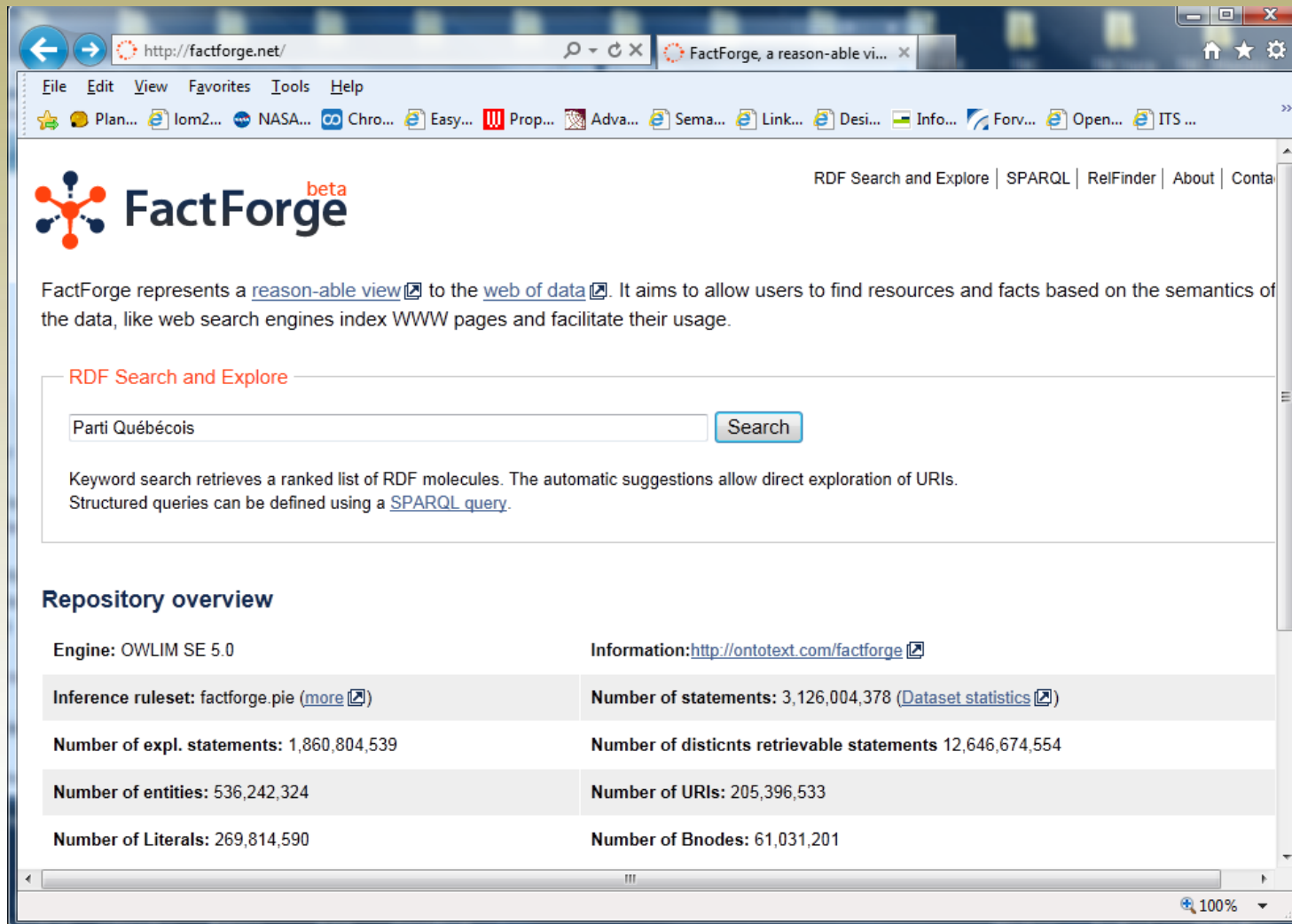

FactForge ^{beta}

RDF Search and Explore | SPARQL | ReIFinder | About | Contact

FactForge represents a [reason-able view](#) to the [web of data](#). It aims to allow users to find resources and facts based on the semantics of the data, like web search engines index WWW pages and facilitate their usage.

RDF Search and Explore

Parti Québécois

Keyword search retrieves a ranked list of RDF molecules. The automatic suggestions allow direct exploration of URIs. Structured queries can be defined using a [SPARQL query](#).

Repository overview

| | |
|---|--|
| Engine: OWLIM SE 5.0 | Information: http://ontotext.com/factforge |
| Inference ruleset: factforge.pie (more) | Number of statements: 3,126,004,378 (Dataset statistics) |
| Number of expl. statements: 1,860,804,539 | Number of distinct retrievable statements: 12,646,674,554 |
| Number of entities: 536,242,324 | Number of URIs: 205,396,533 |
| Number of Literals: 269,814,590 | Number of Bnodes: 61,031,201 |

Mise à disposition libre et ouverte de données gouvernementales



Mise à disposition libre et ouverte de données publiques gouvernementales (2)

The screenshot shows the data.gov.uk website in a browser window. The address bar displays 'http://data.gov.uk/'. The page features a green header with the 'DATA.GOV.UK Beta' logo and the tagline 'Opening up Government'. A navigation menu includes links for Home, Data, Participate, Apps, Location, Linked Data, Library, Lab, and About. The main content area is a carousel of featured articles and announcements:

- What is Linked Data?**: An introduction to Linked Data, featuring a portrait of a man with glasses.
- BATHING QUALITY DATA AS LINKED DATA**: A blog by Dr IAN DICKINSON, featuring a green background and a white link icon.
- SEARCH AND PREVIEW**: New map widgets, featuring a red background with a white compass icon.
- DEPARTMENTAL OPEN DATA STRATEGIES**, featuring a portrait of a man with glasses.
- User Survey**: 2012 User Survey – Now Open, featuring a portrait of a man with glasses.
- data.gov.uk technologies**: New features to get at the data!, featuring a portrait of a man with glasses.

The browser window also shows a 'HM Government' logo and a 'Log in or sign up' link in the top right corner. The bottom of the browser window shows a 100% zoom level.

RDA Vocabularies

The screenshot shows the Open Metadata Registry website at <http://rdvocab.info/>. The page title is "The Registry! :: RDA". The main heading is "open metadata registry" with the tagline "Supporting Metadata Interoperability". There are search boxes for "Search Vocabularies" and "Search Element Sets".

The RDA (Resource Description and Access) Vocabularies

This page provides quick links for the Registered RDA Element Sets and Value Vocabularies. Each set of elements or vocabulary concepts has a link to the general description as well as a link to a list of elements or concepts.

| Category | Item | Format | Feed | Feed | Feed | Status | |
|------------------|---|------------------------------------|-------------------------|----------------------|----------------------|----------------------|--------------|
| RDA Element Sets | FRBR Entities for RDA | Element list (14) | RDF/XML | rss2 | rss1 | atom | New-Proposed |
| | RDA Group 1 Elements | Element list (466) | RDF/XML | rss2 | rss1 | atom | New-Proposed |
| | RDA Group 2 Elements | Element list (59) | RDF/XML | rss2 | rss1 | atom | New-Proposed |
| | RDA Group 3 Elements | Element list (16) | RDF/XML | rss2 | rss1 | atom | New-Proposed |
| | RDA Relationships for Works, Expressions, Manifestations, Items | Element list (508) | RDF/XML | rss2 | rss1 | atom | New-Proposed |
| | RDA Roles | Element list (250) | RDF/XML | rss2 | rss1 | atom | New-Proposed |
| RDA Vocabularies | RDA Applied Material | Concept list (14) | RDF/XML | rss2 | rss1 | atom | New-Proposed |
| | RDA Aspect Ratio | Concept list (3) | RDF/XML | rss2 | rss1 | atom | Published |
| | RDA Base Material | Concept list (24) | RDF/XML | rss2 | rss1 | atom | New-Proposed |
| | RDA Base Material for Microfilm, Microfiche, Photographic Film, and Motion Picture Film | Concept list (6) | RDF/XML | rss2 | rss1 | atom | New-Proposed |
| | RDA Book Format | Concept list (9) | RDF/XML | rss2 | rss1 | atom | Published |
| | RDA Broadcast Standard | Concept list (4) | RDF/XML | rss2 | rss1 | atom | New-Proposed |
| | RDA Carrier Type | Concept list (54) | RDF/XML | rss2 | rss1 | atom | Published |
| | RDA Choruses | Concept list (5) | RDF/XML | rss2 | rss1 | atom | New-Proposed |
| | RDA colour | Concept list (3) | RDF/XML | rss2 | rss1 | atom | New-Proposed |
| | RDA Colour of Moving Images | Concept list (5) | RDF/XML | rss2 | rss1 | atom | New-Proposed |
| | RDA Colour of Still Image | Concept list (6) | RDF/XML | rss2 | rss1 | atom | New-Proposed |
| | RDA Colour of Three-Dimensional Form | Concept list (1) | RDF/XML | rss2 | rss1 | atom | New-Proposed |
| | RDA Configuration of Playback Channels | Concept list (4) | RDF/XML | rss2 | rss1 | atom | New-Proposed |
| | RDA Content Type | Concept list (23) | RDF/XML | rss2 | rss1 | atom | Published |

On the right side, there is a "Browse..." section with links for "Resource Owners", "Vocabularies", and "Schemas". Below that are social media sharing options: +1 (5), Tweet (32), Like (6), and a "Feedback" button.



5. BIBLIOGRAPHIE



Références / bibliographie

1. ISO/IEC 19788-1:2011 Metadata for learning resources – Part1: Framework
(http://standards.iso.org/ittf/PubliclyAvailableStandards/c050772_ISO_IEC_19788-1_2011.zip)
2. Gilles Gauthier. MLR Bindings – Part 1: OWL, RDFS, RDF & XML, GTN-Québec, 2012
Publication #2012-05 (<http://www.gtn-quebec.org/publications>)
3. Gilles Gauthier. Profil d'application Normetic 2.0 (v0.7.5), GTN-Québec, 2011
Publication #2011-01 (<http://www.gtn-quebec.org/publications>)
4. Tom Heath, Christian Bizer. Linked Data: Evolving the Web into a Global Data Space, Morgan & Claypool Publishers
(<http://linkeddatabook.com/editions/1.0/>)
5. GTN-Quebec/lom2mlr (<https://github.com/GTN-Quebec/lom2mlr>)

Contact/Licence

Gilles Gauthier

Professeur associé, Département d'informatique
Université du Québec à Montréal (UQAM)

Courriel: gauthier.gilles@uqam.ca



Identifiant UUID de ce document:

6777ad67-ff90-4dd9-9763-31816a653840

URL: <http://gillesgauthier.net/cmd/GG-2012-11-02.pdf>



Métadonnées pour l'éducation, l'apprentissage et la formation: une approche distribuée globalement supportant la diversité linguistique et culturelle by Gilles Gauthier est mis à disposition selon les termes de la [licence Creative Commons Paternité - Partage des Conditions Initiales à l'Identique 2.5 Canada](#).